

JC010013/WH

Fireguard Next Generation Accessories

Fireguard Next Generation Mains Twist and Lock Bezel Only IP20 White



Features & Benefits

- Slim profile, die-cast aluminium bezels
- Designed specifically for use with Fireguard Next Generation Cans with LED lamps
- IP20/IP65 and IP20 tilt options

Fireguard.
NEXT GENERATION

General Information

Product Group	LED - Replacement Bezel
Product Range	Fireguard® Next Generation
Trade Name	Fireguard®
Color Finish	White
Overall Dimensions	Ø87 x 4.5mm
Origin of manufacturer	Made In China
Warranty	2 year standard warranty (See Website for terms and conditions)
Lighting Product Type 1	Accessory

Construction

Rim Or Attachment	Die-cast Aluminium
-------------------	---------------------------

Packaging

Quantity Per Outer Carton	200
Outer carton(L)- cm	53
Outer carton(W)- cm	31
Outer carton(H)- cm	20

Outer carton overall dimensions	53 x 31 x 20cm
Outer carton Net weight- kg	8.95
Outer carton Gross weight- kg	8.15
Product Bar Code EAN-13 Number	5052544105883
Outer carton Bar Code ITF-14 Number	15052544105880

Standards & Approvals

Manufactured In Accordance To	BS EN 60598:2015, 2-1
CE Marked	Yes
UKCA Marked	Yes
Date code/Purchase order No.	Yes
Certificate Of Conformity	Available on request
Accredited Members	LIA, ISO9001:2015, ISO14001:2015

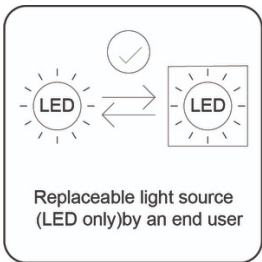
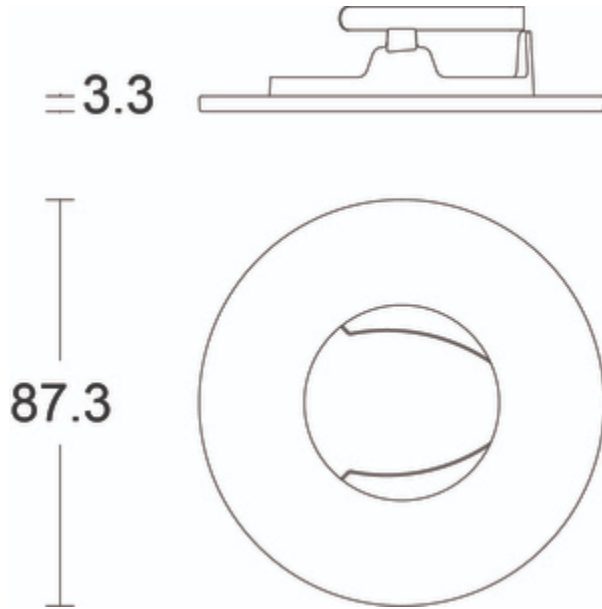

JCC Lighting LTD Innovation Centre, Beeding Close, Southern Cross Trading Estate, Bognor Regis, West Sussex PO22 9TS
Sales: 01243 838999 (8am to 5pm Monday to Friday) Fax: 01243 838998 | sales@jcc.co.uk | www.jcc.co.uk
Company Registration Number: 03044848 | VAT Number: 918544112

This document is uncontrolled if printed, all information is subject to change

Version 84 [23 Apr 2021]