



Crompton Lamps/Phoebe LED
Commercial Lighting Solutions V1.1

Working With Crompton Lamps

Founded in 1878, Crompton Lamps has always been at the forefront of lighting innovation, from installing some of the earliest recorded electrical lights to manufacturing and distributing today's modern lighting solutions.



Experienced Team

Our management team has amassed 50+ years of working within the lighting and electrical industries. This valuable experience plays a vital role in providing the right business direction, product selection and leadership.



Next Day Delivery Service

We offer a competitive and comprehensive Next Day delivery service for orders placed Monday - Friday before 4pm. We are committed to providing a fast and reliable delivery service that customers can depend on.



Dedicated After Sales and Customer Service

Customer service has always been our priority. We want to ensure customers have the best possible experience when working with us. A key part of our service is providing strong after-sales care through our sales and customer service teams.



Broad Range of Lamps, Fittings and Technologies

We offer a complete lighting solution for a variety of applications. We understand that LED technology is the present and future of lighting but we still know the value and marketplace importance of traditional lighting technologies.



Large Stock Holding

Our UK warehouse has stock-holding of circa. £3 million. This ensures we have the products customers need ready to be picked, packed and despatched, day after day, week after week.



Online Portal and Ordering

Our online store and website allows customers to quickly login and receive services that include online ordering, view order history, real-time stock availability and prices, marketing material and detailed product information.



In-house Quality Control and Testing

We have built a strong reputation for quality and remain dedicated to providing customers with the highest standard products. We test all products in our on-site lab and testing facilities, giving us full confidence in our marketplace products.

Recent Projects



Aston Villa Football Club

Aston Villa Football Club chose our Phoebe LED panels and downlights to significantly improve the lighting in their pitch-side foyer and function rooms respectively.



Thruxton Motorsport Centre

At Thruxton Motorsport Centre our Spectrum RGB Halo LED Downlight provided the perfect stylish finish to their reception area and cafe.

Tel: 01274 657 088
Email: sales@cromptonlamps.com
Web: www.cromptonlamps.com



Contents

LED Downlights



Orphica Commercial Downlight	10
Firesafe Downlight	14
Firesafe Eco Downlight	18
Firesafe Smart Downlight	22
Spectrum RGB Downlight	26
Atlanta Universal Fit Downlight	30

LED Battens



Photius IP42 Integrated CCT Batten	36
Oracle IP20 Integrated CCT Batten	40
Lykos IP65 Integrated CCT Batten	44

LED Panels



Galanos Arteson Backlit Panels	50
--------------------------------	----

LED Bulkheads



Melana Round CCT Bulkhead	56
Savoca Internal CCT Ceiling Light	58

LED High Bay



Keto High Bay	64
---------------	----

LED Floodlights



Atlas Commercial Floodlight	70
Atlas Mini Slim-line Floodlight	72

LED Flexi-Strip Kits



Flexi-Strip 5 Meter Kit	78
-------------------------	----

LED Smart Lights



Smart Light Range	84
-------------------	----

LED Emergency Range



Krios Emergency Blade	90
Krios Emergency Wall Box	92
Krios Emergency Bulkhead	96
Krios Emergency Spotlight	98
Krios Emergency Twin Spotlight	100

Lighting Controls



Intelligent Dimmer Switch	106
Smart Relay Switch	108

DOMESTIC & COMMERCIAL LED DOWNLIGHTS



ORPHICA COMMERCIAL
DOWNLIGHT
PAGE 10



FIRESAFE ALL-IN-ONE
DOWNLIGHT
PAGE 14



FIRESAFE ECO
DOWNLIGHT
PAGE 18



FIRESAFE SMART
DOWNLIGHT
PAGE 22



SPECTRUM BLUETOOTH
& WIFI RGB DOWNLIGHT
PAGE 26



ATLANTA UNIVERSAL FIT
DOWNLIGHT
PAGE 30



ORPHICA

Recessed Commercial LED Downlight
Featuring Replaceable Driver



ORPHICA COMMERCIAL LED DOWNLIGHT

Recessed LED Downlight with Replaceable Driver



Quickly Change The Replaceable Driver

All Orphica's in the range have a replaceable driver with quick connection for fast and hassle-free installation.



Quick connect for easy install

Replaceable driver

Not suitable for dimming.

Replaceable Driver

The replaceable driver can be changed for one that better suits your lighting needs.

Quick Connect

The Orphica has been developed with easy installation in mind and features a quick connector for easily changing drivers.

Reflective Cone

All Orphica's in the range feature a reflective cone designed to maximise light output from the recessed LED light source.

IP44 Rated

The IP44 rating makes the Orphica range perfectly suited for a variety of indoor commercial environments and conditions.

Low Glare

The Orphica range emit low glare, providing more comfortable lighting conditions for employees, customers or visitors.

50,000 HOUR LIFE	Cool White 4000K
65° Beam Angle 7W & 12W	75° Beam Angle 24W & 32W
IP44 RATED	RA ≥80 CRI RATING

Warranty

5 YEAR	Manufacturers Warranty
1 YEAR	On-Site Warranty



Applications

With its IP44 rating, reflective cone and recessed design, the Orphica is ideally suited for a wide variety of commercial applications such as hotels, stores, offices and various hospitality premises that require quality low glare lighting.

Reflective Cone

The reflective cone ensures that the recessed LED light source emits maximum light output without loss of quality.



IP44 Rated

Featuring a rating of IP44, the Orphica range is suitable for use in bathroom zones 2 and 3.

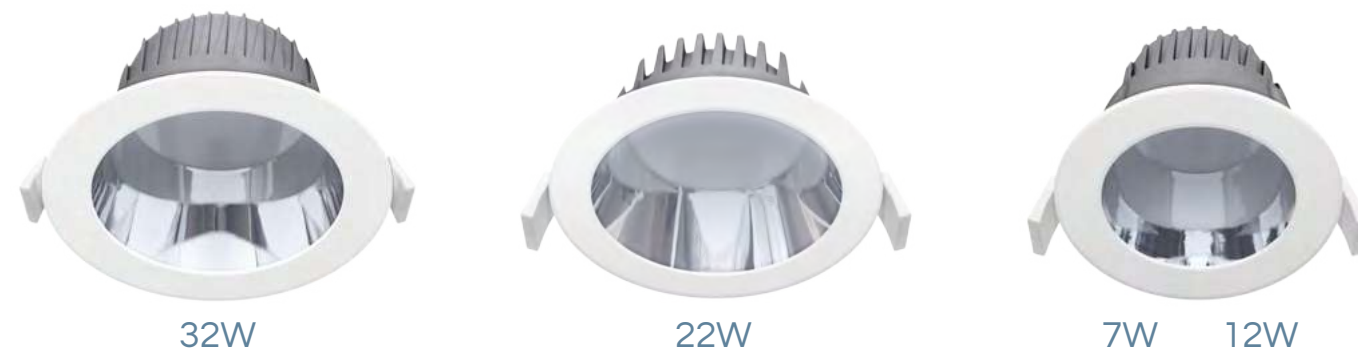

DALI and Emergency Driver options also available. Please ask the sales team for more information.

Product Code	Watts (W)	Volts (V)	Colour Appearance	Colour Temp (K)	Useful Lumens (lm)	Total Lumens (lm)	Efficiency (lm/W)	Beam Angle	Dimensions (mm)			Order Qty
									Dia	H	Cutout ø	
Single Carton												
14985	7	240	Cool White	4000	680	770	97lm/W	65°	102	74	90	1
14992	12	240	Cool White	4000	1360	1550	113lm/W	65°	140	74	120	1
15005	22	240	Cool White	4000	2300	2600	105lm/W	75°	180	96	150	1
15012	32	240	Cool White	4000	3450	3920	108lm/W	75°	230	129	200	1

Tel: 01274 657 088
 Email: sales@cromptonlamps.com
 Web: www.cromptonlamps.com





FIRESAFE

Firesafe All-In-One LED Downlight
IP65 and Fire-Rated



FIRESAFE IP65 LED DOWNLIGHT

All-In-One Dimmable Downlight

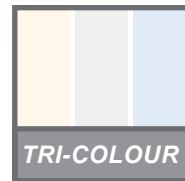

Easy Access Colour Select Switch

The easy access switch is located behind the quick-change magnetic bezel.



Loop-In/Loop-Out

The separate tool-less, quick install loop-in/loop-out constant current driver can be installed during the first phase of a new build or re-wiring project.

Fire Rated

30, 60 & 90 minute fire rated. Fully compliant to BS476 Parts 21 and 22.

IP65 Rated

Suitable for use in bathrooms zone 1-2 and outdoor wet weather use. Complete protection against contact dust.

Dimmable

Smooth dimmable operation with DuoDim Technology, ensuring compatibility with trailing and leading-edge dimmers.

Easy Install

The quick install loop-in/loop-out constant current driver can be installed during the first phase of a new build or re-wiring project.

Insulation Guards

The adjustable guards prevent the Firesafe from being covered by insulation, improving ventilation and increasing safety.

8.5 WATTS	 DIMMABLE
 30, 60 & 90	 TRI-COLOUR
IP65 RATED	60° BEAM ANGLE

Warranty

5 YEAR	Manufacturers Warranty
1 YEAR	On-Site Warranty



Applications

Being both fire and IP65 rated, the Firesafe is the perfect solution for both commercial and domestic applications where safety is a priority such as homes, hotels, apartments and various hospitality premises.



Interchangeable Bezels

Each Firesafe is supplied with white and brushed nickel effect twist-on interchangeable stylish bezels. (Chrome available separately).



Insulation Guards

The adjustable guards prevent the Firesafe from being covered by insulation, improving ventilation and increasing safety.

Product Code	Watts (W)	Volts (V)	Colour Appearance	Colour Temp (K)	Useful Lumens (lm)	Total Lumens (lm)	Efficiency (lm/W)	Beam Angle	Dimensions (mm)			Order Qty	
									Dia	H	Cutout ø		
Single Carton													
12639	8.5	240	Warm/Cool/Daylight	3000/4000/6500	650	700	76lm/W	60°	89	65	70-72	1	
12646-10	Optional Chrome Bezel - 10 Pack										89	5	1

Installation may require advice from a qualified person. Part L Compliant of UK Building Regulations. Part B Compliant BS476 Parts 21 and 22. Suitable for 30 minute 600mm/15mm single layer Standard Wallboard, 60 minute 600mm/12.5mm twin layer Fireboard and 90 minute 450mm/15mm twin layer Fireboard ceilings.

Tel: 01274 657 088
Email: sales@cromptonlamps.com
Web: www.cromptonlamps.com





FIRESAFE ECO

Firesafe Eco Dimmable LED Downlight
IP65 and Fire Rated



ONLY AVAILABLE
WHILE STOCKS LAST

FIRESAFE ECO LED DOWNLIGHT

All-In-One Dimmable Downlight



Warm White	Cool White
3000K	4000K

Loop-In/Loop-Out Quick Install Terminals

The quick install loop-in/loop-out terminal blocks make installation fast and easy, helping to speed up the installation process.



ONLY AVAILABLE WHILE STOCKS LAST

Fire Rated

30, 60 & 90 minute fire rated. Fully compliant to BS476 Parts 21 and 22.

IP65 Rated

Suitable for use in bathrooms zone 1-2 and outdoor wet weather use. Complete protection against contact dust.

Dimmable

Smooth dimmable operation with DuoDim Technology, ensuring compatibility with trailing and leading-edge dimmers.

Easy Install

The Firesafe Eco features tool-less loop-in/loop-out quick connector for fast and easy installation.

3000K or 4000K

The Firesafe Eco is available in 3000K warm white or 4000K cool white colour temperature.

6.7	
WATTS	DIMMABLE
Warm White	Cool White
3000K	4000K
IP65	60°
RATED	BEAM ANGLE

Warranty

3 YEAR	Manufacturers Warranty
1 YEAR	On-Site Warranty



Applications

Being both fire and IP65 rated, the Firesafe Eco provides a quality yet economical solution for commercial and domestic applications where safety is a priority such as homes, hotels and apartments.



Interchangeable Bezels

Each Firesafe Eco is supplied with twist-on interchangeable stylish bezels to complement various decor styles. Included are white and brushed satin finishes. (Chrome available separately).

Product Code	Watts (W)	Volts (V)	Colour Appearance	Colour Temp (K)	Useful Lumens (lm)	Total Lumens (lm)	Efficiency (lm/W)	Beam Angle	Dimensions (mm)				Order Qty	
									Dia	H	W	Cutout ø		
Single Carton														
12868	6.7	240	Warm White	3000	470	540	70lm/W	60°	88	90	100	70-72	1	
12875	6.7	240	Cool White	4000	490	560	73lm/W	60°	88	90	100	70-72	1	
12646-10	Optional Chrome Bezel - 10 Pack										89	5		1

Installation may require advice from a qualified person. Part L Compliant of UK Building Regulations. Part B Compliant BS476 Parts 21 and 22. Suitable for 30 minute 600mm/15mm single layer Standard Wallboard, 60 minute 600mm/12.5mm twin layer Fireboard and 90 minute 450mm/15mm twin layer Fireboard ceilings.

Tel: 01274 657 088
 Email: sales@cromptonlamps.com
 Web: www.cromptonlamps.com





FIRESAFE SMART

Firesafe Smart All-In-One LED Downlight
Voice and App Controlled Downlight



FIRESAFE SMART LED DOWNLIGHT

All-In-One Smart Voice Control Dimmable Downlight



Compatible with Google Home and Amazon Echo

Voice and App Control

Control lights with the touch of a screen or by voice command. Effortlessly instruct lights to turn-on/off, dim down, increase the brightness or change colour temperature.

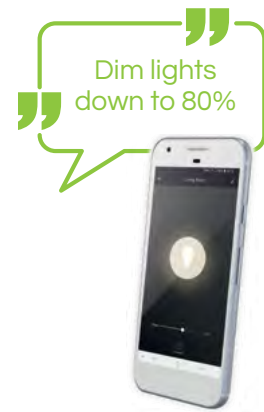

Custom Lighting Schemes and Commands

Create and store custom lighting schemes and commands to be used when you need them.



Requires WIFI 2.4 GHz 802.11b/g/n and Tuya app for set-up. Dimmable via voice control or app. Not compatible with a physical dimmer.

Fire Rated

30, 60 & 90 minute fire rated. Fully compliant to BS476 Parts 21 and 22.

IP65 Rated

Suitable for use in bathrooms zone 1-2 and outdoor wet weather use. Complete protection against contact dust.

Voice or App Control

Lights can be controlled individually or as a group, allowing them all to be controlled as one via voice command or app.

Easy Install

The quick install loop-in/loop-out constant current driver can be installed during the first phase of a new build or re-wiring project.

Insulation Guards

The adjustable guards prevent the Firesafe from being covered by insulation, improving ventilation and increasing safety.

8.5 WATTS	 DIMMABLE
 30, 60 & 90	 TUNEABLE WHITE
IP65 RATED	60° BEAM ANGLE

Warranty

5 YEAR Manufacturers Warranty

1 YEAR On-Site Warranty



Applications

The Firesafe Smart combines both safety and modern wireless functionality. It is an ideal solution for new home build projects, hotels, cafés and apartments.



Interchangeable Bezels

Each Firesafe is supplied with white and brushed nickel effect twist-on interchangeable stylish bezels. (Chrome available separately).

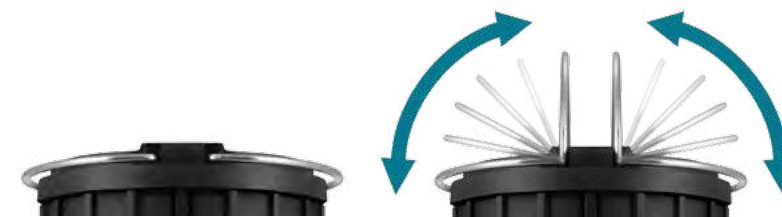

Insulation Guards

The adjustable guards prevent the Firesafe from being covered by insulation, improving ventilation and increasing safety.



Product Code	Watts (W)	Volts (V)	Colour Appearance	Colour Temp (K)	Useful Lumens (lm)	Total Lumens (lm)	Efficiency (lm/W)	Beam Angle	Dimensions (mm)			Order Qty
									Dia	H	Cutout ø	
Single Carton												
12851	8.5	240	Warm/Cool/Daylight	2700-6500	650	700	76lm/W	60°	89	65	70-72	1
12646-10	Optional Chrome Bezel - 10 Pack										1	

Installation may require advice from a qualified person. Part L Compliant of UK Building Regulations. Part B Compliant BS476 Parts 21 and 22. Suitable for 30 minute 600mm/15mm single layer Standard Wallboard, 60 minute 600mm/12.5mm twin layer Fireboard and 90 minute 450mm/15mm twin layer Fireboard ceilings.

Tel: 01274 657 088
Email: sales@cromptonlamps.com
Web: www.cromptonlamps.com





SPECTRUM

Spectrum LED Fire-Rated Downlight
RGB Colour Change Halo



SPECTRUM LED DOWNLIGHT

Twin Light Output All-In-One Bluetooth & Wifi Downlight



Twin Light Outputs

The twin light outputs can be used together or independently. The spotlight features tuneable white colour temperature (2200-6500) and the Halo rim can have a selected static colour or cycle through the full RGB colour spectrum.

App Control

The twin light outputs can easily be controlled via app control. Quickly change the RGB colour rim or adjust the colour temperature of the main light output with the swipe of a finger.



Fire Rated

30, 60 & 90 minute fire rated. Fully compliant to BS476 Parts 21 and 22.

IP65 Rated

Suitable for use in bathrooms zone 1-2 and outdoor wet weather use. Complete protection against contact dust.

Dimmable

Fully dimmable spotlight and halo light. Both lights can be easily dimmed via the impressive and popular Tuya App.

Easy Install

The Spectrum is supplied with a tool-less loop-in/loop-out connector, saving valuable time and making installation fast and easy.

App Control

Control the tuneable spotlight and RGB Halo Rim quickly and easily with a simple swipe of the finger using the Tuya App.

10 WATTS	 DIMMABLE
 30, 60 & 90	50,000 HOUR LIFE
IP65 RATED	40° BEAM ANGLE

Warranty

5 YEAR	Manufacturers Warranty
1 YEAR	On-Site Warranty



Applications

Being both fire and IP65 rated, the Spectrum is the perfect solution for commercial applications where safety and style is a priority such as bars, cafés, restaurants and various hospitality premises.

New Features

New features included on the new wifi enabled model include the ability to sync your music to the RGB colour changing rim, set-up events to automatically turn-on/off, colour change, or dim lights accordingly to time/day schedule.



Interchangeable Bezels

Each Spectrum is supplied with three quick-change magnetic bezels that include white, chrome and aluminium effect.



Gloss Black and Antique Brass bezels available separately.



Product Code	Watts (W)	Volts (V)	Colour Appearance Inner/Outer	Colour Temp (K)	Useful Lumens (lm)	Total Lumens (lm)	Efficiency (lm/W)	Beam Angle	Dimensions (mm)			Order Qty
									Dia	H	Cutout ø	
Spectrum Downlight - Single Carton												
9417b	10	240	CCT/RGB	2200-6500	650	890	65lm/W	40°	80	55	67-70	1
Spectrum Optional Bezels - Single Carton												
10505	Gloss Black Bezel								80			1
10512	Antique Brass Bezel								80			1

Installation may require advice from a qualified person. Part L Compliant of UK Building Regulations. Part B Compliant BS476 Parts 21 and 22. Suitable for 30 minute 600mm/15mm single layer Standard Wallboard, 60 minute 600mm/12.5mm twin layer Fireboard and 90 minute 450mm/15mm twin layer Fireboard ceilings.

Tel: 01274 657 088
Email: sales@cromptonlamps.com
Web: www.cromptonlamps.com





ATLANTA 18.5W

Atlanta Universal Fit LED Downlight
18.5W Model



ATLANTA 6.5W

Atlanta Universal Fit LED Downlight
6.5W Model



ATLANTA UNIVERSAL FIT LED DOWNLIGHT

Adjustable Universal-fit Slim-line Downlight



Fits Any Recess

The unique bracket enables the Atlanta to fit most ceiling cut-outs and provides uniformity on projects where various cut-out sizes are likely to be encountered.



18.5W bracket adjusts from 65mm to 205mm



6.5W bracket adjusts from 65mm to 102mm

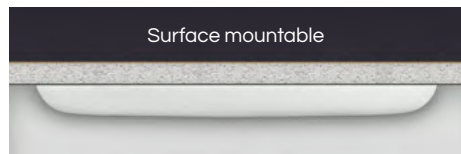
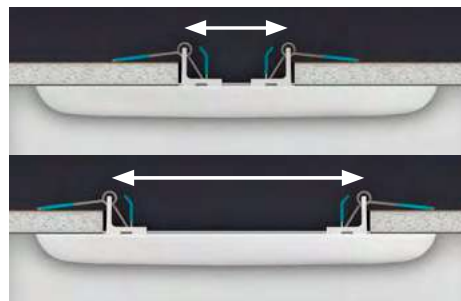

Surface mountable

Slim-line Design for Recessed or Surface Mounting

The Atlanta features a sleek, slim style and compact design with a height of just 15mm for both models. The adjustable clips can be removed allowing the Atlanta to be easily and quickly surface mounted using the robust steel fixing bracket.

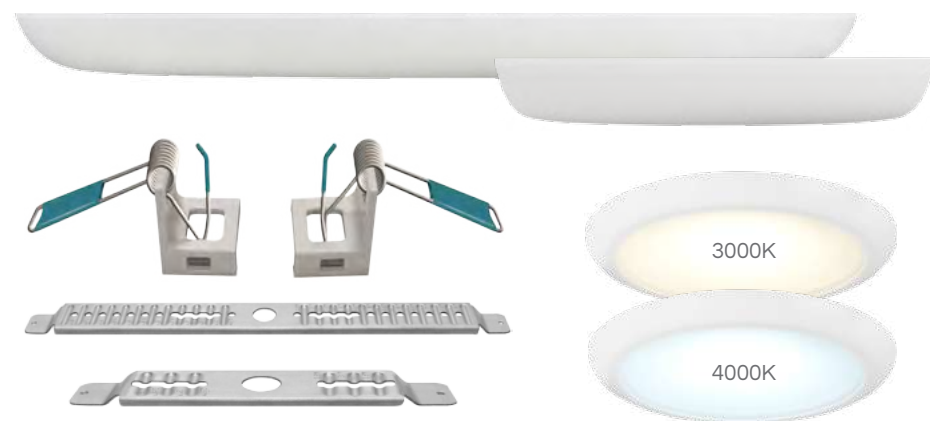

3000K

4000K

Building Regulations

Both the 6.5W and 18.5W models fully comply with building regulations B2.

IP20 Rated

The Atlanta has an IP20 rating making it suitable for indoor use in areas such as corridors, reception areas or stairwells.

Dimmable Models

Smooth dimmable operation with DuoDim Technology ensures compatibility with trailing and leading edge dimmers.

Adjustable Bracket

To keep installation fast and easy the adjustable bracket has an engraved scale guide ensuring clips are adjusted to correct size.

Flicker-Free

The quality on-board driver ensures the Atlanta emits flicker-free light, helping to eliminate eye-strain and headaches.

30,000 HOUR LIFE	 DIMMABLE
Warm White 3000K	Cool White 4000K
IP20 RATED	120° BEAM ANGLE

Warranty

5 YEAR	Manufacturers Warranty
1 YEAR	On-Site Warranty



Applications

The innovative adjustable bracket makes the Atlanta the perfect choice for retrofit projects in offices, hotels and various retail premises where uniformity from past installations is required.

Dimmable and Non-dimmable Options

The dimmable models feature DuoDim Technology, ensuring compatibility with both leading and trailing edge dimmers.



Emergency Conversion Pack

Convert the Atlanta Universal Downlights into emergency versions. The pack features a 3-hour run-time, removable end-caps and quality NiMH battery. (For Non-dim Atlanta models only).

- 3-hour run-time
- NiMH battery
- Removable end caps for easy wiring
- For Atlanta Downlight range only
- 24 hour charge time

1
YEAR

Emergency Battery Warranty



Product Code	Watts (W)	Volts (V)	Colour Appearance	Colour Temp (K)	Total Lumens (lm)	Efficiency (lm/W)	Beam Angle	Dimensions (mm)			Order Qty
								Dia	H	Cutout ø	
Non-Dimmable - Single Carton											
10536	18.5	240	Warm White	3000	1550	84lm/W	120°	230	15	63.5-203	1
10543	18.5	240	Cool White	4000	1600	86lm/W	120°	230	15	63.5-203	1
Dimmable - Single Carton											
12172	6.5	240	Warm White	3000	440	68lm/W	120°	120	15	63.5-102	1
12189	6.5	240	Cool White	4000	460	71lm/W	120°	120	15	63.5-102	1
12196	18.5	240	Warm White	3000	1550	84lm/W	120°	230	15	63.5-203	1
12202	18.5	240	Cool White	4000	1600	86lm/W	120°	230	15	63.5-203	1
Emergency Conversion Pack - Single Carton											
RBF230/4/M3	Dimensions (mm) = Compact - 270mm x 68mm, Extended - 515mm x 42mm									1	

Dimmable model is compatible with most LED dimmer switches.
Emergency conversion pack suitable for Non-dimmable models only

Tel: 01274 657 088
Email: sales@cromptonlamps.com
Web: www.cromptonlamps.com



INTERIOR & EXTERIOR LED BATTENS



PHOTIUS IP42 INTEGRATED CCT BATTEN
PAGE 36



ORACLE IP20 INTEGRATED CCT BATTEN
PAGE 40



LYKOS IP65 INTEGRATED CCT BATTEN
PAGE 44



PHOTIUS

Photius Integrated CCT LED Batten
IP42 High Efficiency Batten



PHOTIUS INTEGRATED CCT LED BATTEN

IP42 Flicker-free and High Efficiency LED Batten



3-Hour Emergency Model

- Discharge ≥ 3 Hours at 960lm
- 24 hours charge time
- Built-in emergency test-function

1 YEAR Emergency Battery Warranty



Microwave Sensor Model

- 6m max detection range
- 5secs - 10min hold time
- 120° detection angle
- Easy access module for quick adjustment to sensor settings



Suspension and Surface Mountable

The Photius has a sleek, slim style and compact design with a height of just 36mm and is suitable for suspension or surface mounting.

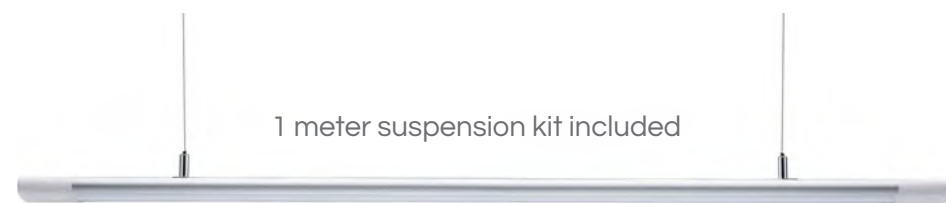

Not suitable for dimming.

Slim & Stylish Design

The Photius has a slim and sleek design, offering both style and quality light.

IP42 Rated

The IP42 rating makes the Photius perfectly suited for a variety of indoor office work environments and conditions.

High Efficiency

The Photius offers high efficiency at 120lm/W, combining efficiency with performance, style and easy installation.

Flicker-Free

A key feature of the Photius is that it emits flicker-free light, helping to create a more comfortable lighting environment.

Tri-Colour Selection

The easy access switch allows the colour temperature to be quickly changed between 3000K, 4000K or 6000K.

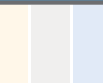
35,000 HOUR LIFE	 CLASS 1
120lm/W EFFICIENCY	 TRI-COLOUR
IP42 RATED	120° BEAM ANGLE

Warranty

- 5 YEAR** Manufacturers Warranty
- 1 YEAR** On-Site Warranty



Applications

The stylish, slim-line Photius is the ideal solution for settings such as offices, hotels and other commercial applications that require quality light.

Quick and Easy Installation

Standard and microwave sensor feature quick 3-way terminal block for quick installation.

The emergency model features 4-way terminal block for quick installation and continuous live feed.



Easy Access Switch

The end cap can be removed to allow fast access to the colour changing switch.



Product Code	Watts (W)	Volts (V)	Product Description	Colour Temp (K)	Total Lumens (lm)	Efficiency (lm/W)	Beam Angle	Dimensions (mm)			Order Qty
								W	H	L	
Standard - Single Carton											
12219	40	240	4ft Standard	3000/4000/6000	4800	120lm/W	120°	80	36	1190	1
12240	60	240	5ft Standard	3000/4000/6000	7200	120lm/W	120°	80	36	1490	1
Microwave Sensor* - Single Carton											
12226	40	240	4ft Microwave Sensor	3000/4000/6000	4800	120lm/W	120°	80	36	1190	1
12257	60	240	5ft Microwave Sensor	3000/4000/6000	7200	120lm/W	120°	80	36	1490	1
3-Hour Emergency** - Single Carton											
12233	40	240	4ft Emergency Sensor	3000/4000/6000	4800	120lm/W	120°	80	36	1190	1
12264	60	240	5ft Emergency Sensor	3000/4000/6000	7200	120lm/W	120°	80	36	1490	1

* 6m Detection range. 5s-10min Hold time 5-∞ lum light sensor Instant off or 20% light output after hold time when sensor not triggered. 30s-∞ dimming level hold.

** Emergency Discharge ≥ 3 Hours at 960lm, 24 hour charge time required. Built in Emergency test function. Fitted with a 4 Way Terminal block for Permanent Live.

Tel: 01274 657 088
Email: sales@cromptonlamps.com
Web: www.cromptonlamps.com





ORACLE

Oracle Integrated CCT LED Batten
IP20 Fast Install Batten



ORACLE INTEGRATED CCT LED BATTEN

IP20 Easy Installation LED Batten



3-Hour Emergency Models

- 3 hours discharge time
- 24 hours charge time
- Available in 4ft, 5ft and 6ft lengths (High Output also available)

1 YEAR Emergency Battery Warranty

High-Output Models

- Available in 40W, 60W and 80W
- Available in 4ft, 5ft and 6ft lengths
- High efficiency = 100lm/W



Not suitable for dimming.

IK04 Impact Rating

The Oracle features a robust steel construction and shatterproof diffuser.

IP20 Rated

The IP20 rating makes the Oracle perfectly suited for a variety of indoor office work environments and conditions.

Fast Install Terminal

To assist with making installation quick and easy, the Oracle features a 3-way terminal block.

Flip-down End Caps

The Oracle's end caps can be easily flipped down, allowing fast access to the colour changing technology (CCT) switch.

Tri-Colour Selection

The easy access switch allows the colour temperature to be quickly changed between 3000K, 4000K or 5700K.

50,000 HOUR LIFE	 CLASS 1
IK04 RATED	 TRI-COLOUR
IP20 RATED	120° BEAM ANGLE

Warranty

5 YEAR	Manufacturers Warranty
1 YEAR	On-Site Warranty



Applications

The reliable, robust and dependable Oracle is the perfect solution for settings such as offices, hotels and other commercial areas where quality light and reliability is required.

Easy Access Switch

The Oracle features flip-down end caps allowing quick and easy access to the colour changing technology (CCT) switch. Users can choose and switch between 3000K, 4000K or 5700K.

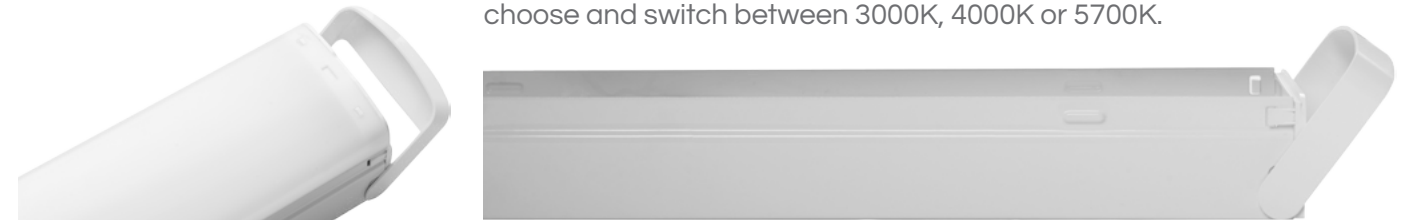

DALI Driver and PIR plug-in options also available. Please ask the sales team for more information.

Product Code	Watts (W)	Volts (V)	Product Description	Colour Temp (K)	Total Lumens (lm)	Efficiency (lm/W)	Beam Angle	Dimensions (mm)			Order Qty
								W	H	L	
Standard - Single Carton											
14350	20	240	4ft Standard	3000/4000/5700	2000	100lm/W	120°	85	75	1200	1
14374	30	240	5ft Standard	3000/4000/5700	3000	100lm/W	120°	85	75	1500	1
14398	40	240	6ft Standard	3000/4000/5700	4000	100lm/W	120°	85	75	1800	1
Emergency - Single Carton											
14367	20	240	4ft Emergency	3000/4000/5700	2000	100lm/W	120°	85	75	1200	1
14381	30	240	5ft Emergency	3000/4000/5700	3000	100lm/W	120°	85	75	1500	1
14404	40	240	6ft Emergency	3000/4000/5700	4000	100lm/W	120°	85	75	1800	1
High Output - Single Carton											
14411	40	240	4ft High Output	3000/4000/5700	4000	100lm/W	120°	85	75	1200	1
14435	60	240	5ft High Output	3000/4000/5700	6000	100lm/W	120°	85	75	1500	1
14459	80	240	6ft High Output	3000/4000/5700	8000	100lm/W	120°	85	75	1800	1
Emergency High Output - Single Carton											
14428	40	240	4ft HO Emergency	3000/4000/5700	4000	100lm/W	120°	85	75	1200	1
14442	60	240	5ft HO Emergency	3000/4000/5700	6000	100lm/W	120°	85	75	1500	1
14466	80	240	6ft HO Emergency	3000/4000/5700	8000	100lm/W	120°	85	75	1800	1

Emergency Discharge ≥ 3 Hours, 24 hour charge time required.

Tel: 01274 657 088
 Email: sales@cromptonlamps.com
 Web: www.cromptonlamps.com





LYKOS

Lykos Integrated CCT LED Batten
IP65 Non-Corrosive LED Batten



LYKOS IP65 INTEGRATED CCT LED BATTEN

Robust IP65 Non-Corrosive LED Batten



Suitable for conduit, suspension and surface mounting.

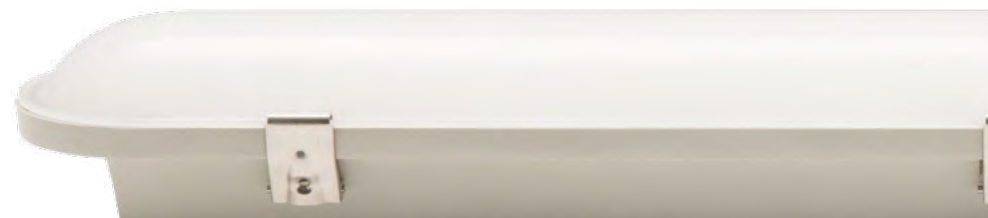

3-Hour Emergency Models

- 3 hours discharge time
- 24 hours charge time
- Available in 4ft, 5ft and 6ft lengths (High Output also available)

1 YEAR Emergency Battery Warranty



High-Output Models

- Available in 40W, 60W and 80W
- Available in 4ft, 5ft and 6ft lengths
- High efficiency = 100lm/W

6ft only available in High Output
Not suitable for dimming.

IK08 Impact Rating

Constructed from tough IK08 moisture and acid resistant polycarbonate.

IP65 Rated

The IP65 rating makes the Lykos perfectly suited for a wide variety of outdoor environments and conditions.

Operating Temp.



The Lykos can operate in a wide temperature range of -20° to 40° without any issue. (Emergency versions = 0° to 40°).

Loop-in/Loop-Out

A key feature of the Lykos is the two tool-less loop through terminal blocks that allows for single or for fitting-to-fitting installation.

Tri-Colour Selection

The easy access switch allows the colour temperature to be quickly changed between 3000K, 4000K or 5700K.

50,000 HOUR LIFE	 CLASS 2
IK08 RATED	 TRI-COLOUR
IP65 RATED	120° BEAM ANGLE

Warranty

- 5 YEAR** Manufacturers Warranty
- 1 YEAR** On-Site Warranty



Applications

The Lykos IP65 batten offers dependability, reliability and toughness, making it ideally suited for use in a variety of outdoor/wet condition settings such as undercover car-parks, industrial workplaces and warehouses.

Fast Loop Through Terminal Blocks

Features two tool-less loop through terminal blocks (emergency model has continuous live feed) for easy install of multiple luminaires.



Anti-Vandal Clips

The Lykos features anti-vandal clips offering extra security and durability.



DALI Driver and PIR plug-in options also available. Please ask the sales team for more information.

Product Code	Watts (W)	Volts (V)	Product Description	Colour Temp (K)	Total Lumens (lm)	Efficiency (lm/W)	Beam Angle	Dimensions (mm)			Order Qty
								W	H	L	
Standard - Single Carton											
14251	20	240	4ft Standard	3000/4000/5700	2000	100lm/W	120°	80	72	1200	1
14275	30	240	5ft Standard	3000/4000/5700	3000	100lm/W	120°	80	72	1500	1
Emergency - Single Carton											
14268	20	240	4ft Emergency	3000/4000/5700	2000	100lm/W	120°	80	72	1200	1
14282	30	240	5ft Emergency	3000/4000/5700	3000	100lm/W	120°	80	72	1500	1
High Output - Single Carton											
14299	40	240	4ft High Output	3000/4000/5700	4000	100lm/W	120°	105	87	1200	1
14312	60	240	5ft High Output	3000/4000/5700	6000	100lm/W	120°	105	87	1500	1
14336	80	240	6ft High Output	3000/4000/5700	8000	100lm/W	120°	105	87	1800	1
Emergency High Output - Single Carton											
14305	40	240	4ft Emergency HO	3000/4000/5700	4000	100lm/W	120°	105	87	1200	1
14329	60	240	5ft Emergency HO	3000/4000/5700	6000	100lm/W	120°	105	87	1500	1
14343	80	240	6ft Emergency HO	3000/4000/5700	8000	100lm/W	120°	105	87	1800	1

Emergency Discharge ≥ 3 Hours, 24 hour charge time required.

Tel: 01274 657 088
Email: sales@cromptonlamps.com
Web: www.cromptonlamps.com



HIGH EFFICIENCY BACKLIT LED PANELS

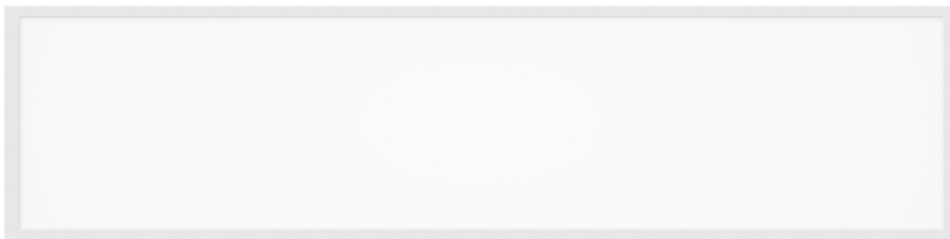

GALANOS ARTESON 600 X 600 & 1200 x 300 BACKLIT PANEL
PAGE 50



GALANOS ARTESON

Galanos Arteson Backlit LED Panel
600 x 600 Flicker-free LED Panel



GALANOS ARTESON

Galanos Arteson Backlit LED Panel
1200 x 300 Flicker-free Model

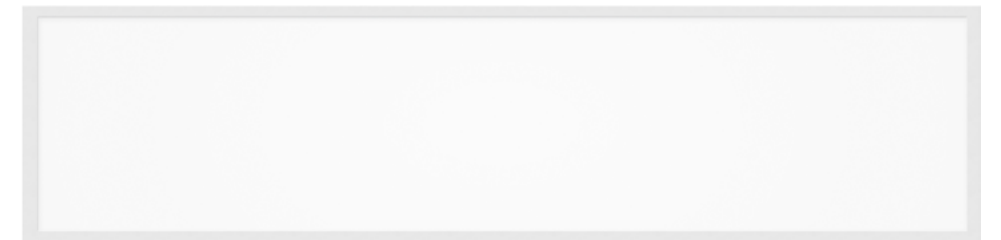

GALANOS ARTESON BACKLIT LED PANEL

High-Efficiency Backlit LED Panel



Backlit LED Technology

The impressive backlit LED technology ensures that the Galanos Arteson range emits even quality light across the entire panel, improving efficiency and standard of light output.

Emergency Kit

The optional emergency kit converts the Arteson panels into emergency versions. (For use with Galanos Arteson range only).

- 3-hour run-time
- Built-in lithium battery

1 YEAR Emergency Battery Warranty



Not suitable for dimming.

UGR<19 Model

TPa Rated - The Galanos Arteson UGR<19 model is rated to TPa standards.

38 WATTS	IP20 RATED
100lm/W EFFICIENCY	30,000 HOUR LIFE

600 x 600 - TPb Rated

The Galanos Arteson 600 x 600 model is rated to TPb standards.

1200 x 300 - TPa Rated

The Galanos Arteson 1200 x 300 model is rated to TPa standards.

High Efficiency

Both 40W models offer high efficiency at 80lm/W, combining efficiency with reliability and quality light output.

UK Emergency Kits

Emergency kits are available for the Galanos Arteson range allowing panels to be converted into emergency panels.

40 WATTS	30,000 HOUR LIFE
80lm/W EFFICIENCY	IP20 RATED

Warranty

5 YEAR Manufacturers Warranty

1 YEAR On-Site Warranty



Applications

The Galanos Arteson's reliability and dependability make it ideally suited for settings such as offices, hospitality and other commercial applications that require quality light.

Surface and Suspension Mountable

The Galanos Arteson range can be surface or suspension mounted. Mounting accessories are available to ensure that the Arteson can be installed in a variety of settings.



DALI Driver option available for 1200 x 300 model. Please ask the sales team for more information.

Product Code	Watts (W)	Volts (V)	Product Description	Colour Temp (K)	Total Lumens (lm)	Efficiency (lm/W)	Beam Angle	Dimensions (mm)			Order Qty
								W	L	D	
Low Glare UGR19 600 x 600 - Single Carton											
14121	38	240	TP(a) 600 x 600 UGR<19 Panel	3000	3800	100lm/W	110°	595	595	30	1
14138	38	240	TP(a) 600 x 600 UGR<19 Panel	4000	3800	100lm/W	110°	595	595	30	1
600 x 600 - Single Carton											
14473	40	240	TP(b) 600 x 600 Panel	3000	3200	80lm/W	110°	595	595	30	1
14480	40	240	TP(b) 600 x 600 Panel	4000	3200	80lm/W	110°	595	595	30	1
14497	40	240	TP(b) 600 x 600 Panel	6000	3200	80lm/W	110°	595	595	30	1
1200 x 300 - Single Carton											
14503	40	240	TP(a) 1200 x 300 Panel	4000	3200	80lm/W	110°	295	1195	30	1
Accessories - Single Carton											
14527	3-Hour Emergency Kit for Galanos Arteson Panel							73	212	28	1
14510	Wire Suspension Kit for Galanos Arteson Panel							50 to 950mm drop			1
14534	600 x 600 Surface Mounting Kit for Galanos Arteson Panel							600	600	65	1
14541	1200 x 300 Surface Mounting Kit for Galanos Arteson Panel							300	1200	65	1

Tel: 01274 657 088
 Email: sales@cromptonlamps.com
 Web: www.cromptonlamps.com



INTERIOR & EXTERIOR LED BULKHEADS



MELANA ROUND IP65 BULKHEAD
PAGE 56

SAVOCA TRI-COLOUR INTERIOR BULKHEAD
PAGE 58



MELANA

Melana Round CCT LED Bulkhead
IP65 with Dual Wattage Selection



SAVOCA

Savoca LED Internal Ceiling Light
IP65 Tri-Colour Select



MELANA ROUND CCT LED BULKHEAD

IP65 Rated Dual Wattage Tri-Colour Select Bulkhead



Adjustable Wattage

The wattage can be switched between 11W or 15W.

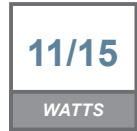

Fast and Easy Installation with Side Conduit Entry

The Melana features a tool-less loop-in/loop-out connector and side conduit entry, making installation fast and easy.



Tri-Colour Selection

The colour temperature can be quickly selected or changed from 3000K, 4000K or 6500K.



Not suitable for dimming.

IP65 Rated

The IP65 rating allows the Melana to be utilised in a variety of outdoor settings.

Flicker-Free

A key feature of the Melana is that it emits flicker-free light, helping to create a more comfortable lighting environment.

Microwave Sensor

The microwave sensor models feature dusk-til-dawn functionality, lighting areas in low light conditions when required.

3-Hour Emergency

The 3-hour emergency models feature an integrated emergency module with internal indicator light.

Robust and Reliable

Featuring an IK10 impact rating and constructed from tough corrosion-resistant plastic the Melana is both robust and reliable.

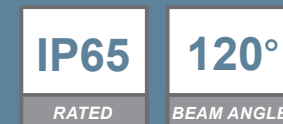
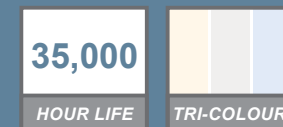
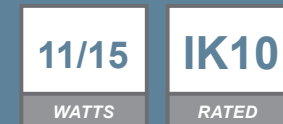

Warranty



Applications

With an IP65 rating and tough construction, the Melana is an ideal solution for outdoor applications where moisture is likely to be encountered such as external hospitality, hotel or office building walls or ceilings.

Optional Eyelid or Grille Cover

The optional eyelid and grille cover features a robust, corrosion-resistant construction and IP65 rating.

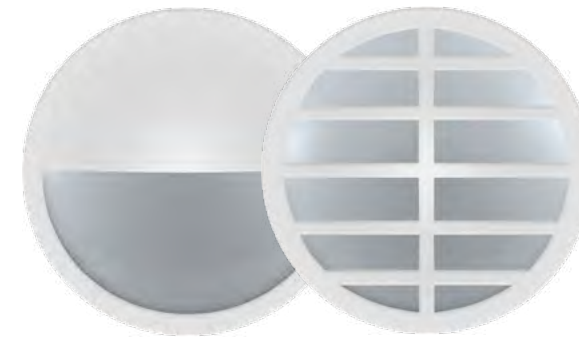

Product Code	Watts (W)	Volts (V)	Product Finish	Colour Temp (K)	Total Lumens (lm)	Efficiency (lm/W)	Beam Angle	Dimensions (mm)		Order Qty
								Dia	H	
Standard - Single Carton										
14145	11 or 15	240	White	3000/4000/6500K	11W 1000/15W 1500	80lm/W	120°	300	85	1
Microwave Sensor* - Single Carton										
14152	11 or 15	240	White	3000/4000/6500K	11W 1000/15W 1500	80lm/W	120°	300	85	1
3-Hour Emergency** - Single Carton										
14169	11 or 15	240	White	3000/4000/6500K	11W 1000/15W 1500	80lm/W	120°	300	85	1
Microwave Sensor* and 3-Hour Emergency** - Single Carton										
14176	11 or 15	240	White	3000/4000/6500K	11W 1000/15W 1500	80lm/W	120°	300	85	1
Optional Eyelid Cover - Single Carton										
14688			White					300		1
Optional Grille Cover - Single Carton										
14695			White					300		1

* Microwave sensor with variable range, hold time, daylight threshold, stand-by period and stand-by dimming level.

** Charging time 24hrs - Running time 3hrs at reduced output.

Tel: 01274 657 088
 Email: sales@cromptonlamps.com
 Web: www.cromptonlamps.com



SAVOCA LED INTERNAL CEILING LIGHT

IP65 Rated Tri-Colour Select



1 YEAR Emergency Battery Warranty



Loop-In/Loop-Out

The Savoca features an easy access tool-less loop-in/loop-out connector, saving valuable time and making installation fast and easy.

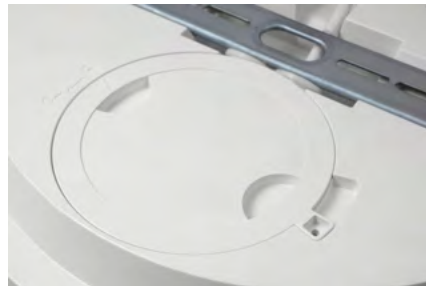

Tri-Colour Select

The colour temperature can be quickly selected or changed from 3000K, 4000K or 6500K.



Not suitable for dimming.

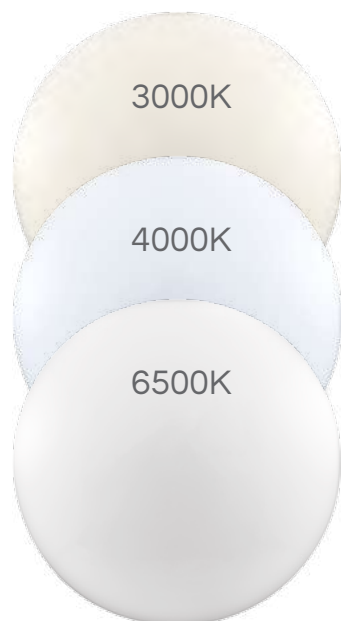

Slim-line Design

The slim-line design ensures the Savoca is at home in any office or work environment.

Flicker-Free

A key feature of the Savoca is that it emits flicker-free light, helping to create a more comfortable lighting environment.

Microwave Sensor

The microwave sensor models feature dusk-till-dawn functionality, lighting areas in low light conditions when required.

3-Hour Emergency

The 3-hour emergency models feature an integrated emergency module with internal indicator light.

Stylish and Reliable

Featuring an IK10 impact rating and constructed from tough corrosion-resistant plastic the slim-line Savoca is both stylish and reliable.

100lm/W EFFICIENCY	IK10 RATED
35,000 HOUR LIFE	TRI-COLOUR
IP65 RATED	120° BEAM ANGLE

Warranty

5 YEAR	Manufacturers Warranty
1 YEAR	On-Site Warranty



Applications

The slim-line design and flicker-free light output make the Savoca the ideal choice for work environments such as offices, clinics, hotels and other hospitality applications.

Robust and Reliable

The Savoca features a tough polycarbonate construction with an IK10 impact rating for added durability.

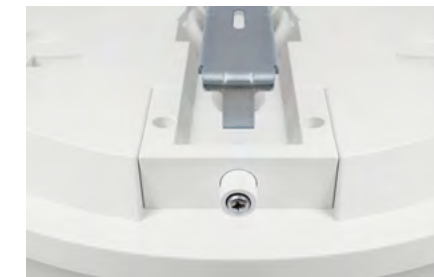

IP65
RATED

Features a push-fit bracket with a push-button release for easy maintenance.

Product Code	Watts (W)	Volts (V)	Product Finish	Colour Temp (K)	Total Lumens (lm)	Efficiency (lm/W)	Beam Angle	Dimensions (mm)		Order Qty
								Dia	H	
Standard - Single Carton										
14589	12	240	White	3000/4000/6500K	1000	83lm/W	120°	300	59	1
14626	18	240	White	3000/4000/6500K	1800	100lm/W	120°	300	59	1
Microwave Sensor* - Single Carton										
14596	12	240	White	3000/4000/6500K	1000	83lm/W	120°	300	59	1
14633	18	240	White	3000/4000/6500K	1800	100lm/W	120°	300	59	1
3-Hour Emergency** - Single Carton										
14602	12	240	White	3000/4000/6500K	1000	83lm/W	120°	300	59	1
14640	18	240	White	3000/4000/6500K	1800	100lm/W	120°	300	59	1
Microwave Sensor* and 3-Hour Emergency** - Single Carton										
14619	12	240	White	3000/4000/6500K	1000	83lm/W	120°	300	59	1
14657	18	240	White	3000/4000/6500K	1800	100lm/W	120°	300	59	1

* Microwave sensor with variable range, hold time, daylight threshold, stand-by period and stand-by dimming level.
** Charging time 24hrs - Running time 3hrs at reduced output.

Tel: 01274 657 088
Email: sales@cromptonlamps.com
Web: www.cromptonlamps.com



HIGH POWERED LED HIGH BAY



KETO HIGH POWERED COMMERCIAL LED HIGH BAY
PAGE 64



KETO

Keto Commercial High Bay
High Powered With Surge Protection



KETO LED HIGH BAY

High Powered Surge Protected Commercial High Bay



No Heat Build-up

Driver is located away from the main body and heat sink creating better ventilation and allowing heat to dissipate. The fins allow heat to pass through, helping to keep the Keto cool.



Flicker-Free and Anti-Glare

The Keto emits flicker-free and anti-glare light, helping to create a more comfortable lighting environment. The Keto can operate in temperatures between -40° to 45° without issue.



Emergency Models

Emergency models are ideal for situations where emergency lighting is required in spaces such as warehouses or food processing plants.

- 3-hour emergency function
- EN60598-2-22-2015 emergency luminaire compliant
- Remote emergency driver with replaceable LiFePo4 6.4 3.0Ah 1800mAh rechargeable battery
- Test function and LED indicator
- 24 hour charge time
- Lightweight aluminium construction with black finish
- IP65 rated
- 0-10v dimming
- Suitable for use with Keto Microwave Motion Sensor

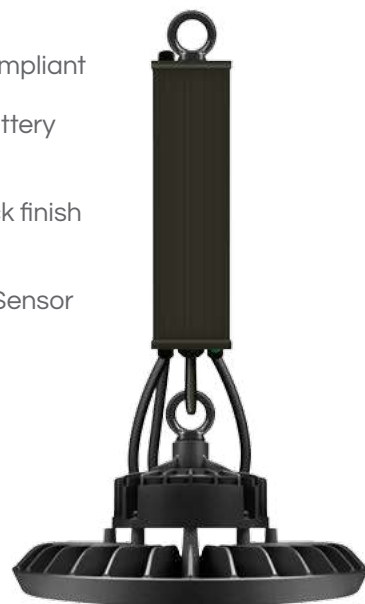

1 YEAR Emergency Battery Warranty

Emergency Pack Dimension:
Depth = 61mm
Height = 388mm
Width = 93mm

Glass Free Build

The Keto features a glass-free construction and a shatterproof diffuser.

IK10 Rated

Protected against 20 joules of impact. Equivalent impact of 5KG mass dropped from 400mm above the impacted surface.

High Efficiency

The Keto features $\geq 96\text{lm/W}$ high efficiency making it extremely energy efficient while still offering high performance.

Attachable Eye-Bolt

An attachable screw-in eye bolt is supplied with every Keto. The eye-bolt speeds up installation by giving point-to-point installation.

Surge Protection

The Keto has 4KV surge protection and is protected against power surges up to 4000 volts, offering extra safety and reliability.

$\geq 96\text{lm/W}$	≥ 25
EFFICIENCY	UGR
50,000	Cool White
HOUR LIFE	4000K
IP65	IK10
RATED	RATED

Warranty

- 5 YEAR** Manufacturers Warranty
- 1 YEAR** On-Site Warranty



Applications

Designed and developed to be versatile and dependable, the Keto is an ideal solution for a wide range of industrial lighting applications such as warehouses, farming/agriculture and food/drink processing.

Microwave Motion Sensor Module

The microwave sensor module converts the Keto into a microwave sensor version. It attaches safely and securely with the robust metal arm and offers a range of functions via the remote control.

- Detection area 25%, 50%, 75%, 100% (15m maximum mounted height)
- Detection range Max (D x H): 16m x 15m
- Hold time 5s, 30s, 1min, 3min, 5min, 10min, 20min, 30min
- Daylight threshold 2Lux, 10Lux, 30Lux, 50Lux, 80Lux, 120Lux, Disable
- Stand-by period 0s, 10s, 30s, 1min, 5min, 10min, 30min
- Stand-by dimming level 10%, 20%, 30% 50%
- Separate remote control unit required (Product Code: 14732)



Product Code	Watts (W)	Volts (V)	Colour Appearance	Colour Temp (K)	Useful Lumens (lm)	Total Lumens (lm)	Efficiency (lm/W)	Beam Angle	Keto High Bay Dimensions (mm)		Order Qty
									Dia	H	
90° - Single Carton											
12431	100	240	Cool White	4000	9800	13000	98lm/W	90°	275	166	1
12448	150	240	Cool White	4000	14500	18000	97lm/W	90°	285	166	1
12455	200	240	Cool White	4000	19100	24000	96lm/W	90°	305	183	1
60° - Single Carton											
12462	100	240	Cool White	4000	9800	13000	98lm/W	60°	275	166	1
12479	150	240	Cool White	4000	14500	18000	97lm/W	60°	285	166	1
12486	200	240	Cool White	4000	19100	24000	96lm/W	60°	305	183	1
Emergency 90° - Single Carton											
15029	100	240	Cool White	4000	9800	13000	98lm/W	90°	275	166	1
15036	150	240	Cool White	4000	14500	18000	97lm/W	90°	285	166	1
15043	200	240	Cool White	4000	19100	24000	96lm/W	90°	305	183	1
Emergency 60° - Single Carton											
15050	100	240	Cool White	4000	9800	13000	98lm/W	60°	275	166	1
15067	150	240	Cool White	4000	14500	18000	97lm/W	60°	285	166	1
15074	200	240	Cool White	4000	19100	24000	96lm/W	60°	305	183	1
Microwave Sensor Module											
14107	Phoebe LED Keto Microwave Sensor Module										1
14732	Phoebe LED Keto Microwave Sensor Remote Control										1

Tel: 01274 657 088
Email: sales@cromptonlamps.com
Web: www.cromptonlamps.com



DOMESTIC & COMMERCIAL LED FLOODLIGHTS



ATLAS COMMERCIAL FLOODLIGHT
PAGE 70



ATLAS MINI SLIM-LINE FLOODLIGHT
PAGE 72



ATLAS COMMERCIAL

Atlas Commercial High Powered Floodlight
Available With Photocell Sensor



ATLAS MINI

Atlas Mini Slim-line Floodlight
Available With PIR Sensor



ATLAS COMMERCIAL LED FLOODLIGHT

Available With or Without Photocell Sensor



360°



Adjustable 360° Mounting Bracket

The 360 degrees adjustable mounting bracket allows for easier installation in a variety of mounting positions.

100W
9900lm total lumens
8400lm useful lumens
84lm/W

150W
15600lm total lumens
13200lm useful lumens
88lm/W

200W
20200lm total lumens
17100lm useful lumens
86lm/W

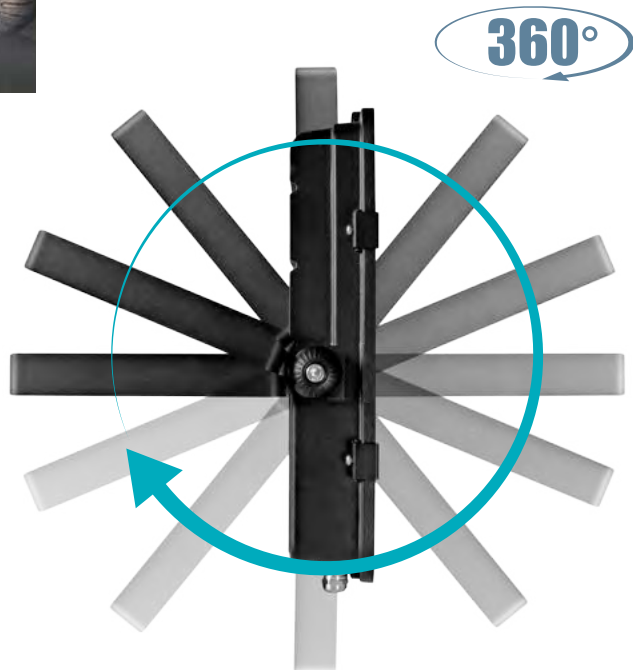

Not suitable for dimming.

IK04 Rated

Protected against 0.5 joules of impact dropped from 200mm above surface.

IP65 Rated

The IP65 rating ensures the Atlas Commercial can operate without issue in a variety of wet outdoor conditions.

High Powered

Available in 100W, 150W, and 200W the Atlas Commercial can illuminate large outdoor industrial areas with ease.

Adjustable Bracket

The 360° adjustable mounting bracket allows the installer to position the Atlas to direct light and illuminate a specific area.

Photocell Sensor

The Photocell Sensor models feature dusk-til-dawn photocell functionality, lighting areas in low light conditions when required.

30,000 HOUR LIFE	IK04 RATED
≥ 84lm/W EFFICIENCY	Cool White 4000K
IP65 RATED	110° BEAM ANGLE

Warranty

5 YEAR	Manufacturers Warranty
1 YEAR	On-Site Warranty



Applications

The Atlas Commercial is the perfect solution for lighting projects that require large outdoor areas to be illuminated such as car parks, shipping yards, construction sites or up-lighting buildings.

IP65 Rating

The Atlas Commercial features an IP65 rating offering complete protection against contact dust and water.

Photocell Models

Photocell models automatically illuminate in low lux level settings thanks to the dusk-til-dawn feature.



Product Code	Watts (W)	Volts (V)	Colour Appearance	Colour Temp (K)	Useful Lumens (lm)	Total Lumens (lm)	Efficiency (lm/W)	Beam Angle	Dimensions (mm)			Weight (kg)	Order Qty
									W	H	D		
Standard - Single Carton													
12103	100	240	Cool White	4000	8400	9900	84lm/W	110°	257	340	59	3.4	1
12110	150	240	Cool White	4000	13200	15600	88lm/W	110°	280	374	63	4.1	1
12127	200	240	Cool White	4000	17100	20200	86lm/W	110°	299	414	69	5	1
Photocell Sensor - Single Carton													
14183	100	240	Cool White	4000	8400	9900	84lm/W	110°	257	340	59	3.4	1
14190	150	240	Cool White	4000	13200	15600	88lm/W	110°	280	374	63	4.1	1
14206	200	240	Cool White	4000	17100	20200	86lm/W	110°	299	414	69	5	1

Terminal block not included. Installation may require advice from a qualified person.

Tel: 01274 657 088
Email: sales@cromptonlamps.com
Web: www.cromptonlamps.com



ATLAS MINI SLIM-LINE LED FLOODLIGHT

Available With or Without PIR Sensor



Slim-line Design and Fast Install

The Atlas Mini Slim-line Floodlight features a stylish, slim design with an angled mounting bracket designed for fast installation.



PIR Models

The PIR models feature a 120° monitoring angle with lux level controls, sensitivity controls and time controls. Maximum detection range of up to 8m and light hold detection is selectable from 10 seconds to 7 minutes.

Not suitable for dimming.

Slim-line Design

Die-cast aluminium construction with stylish thin body design.

IP65 Rated

The Atlas Mini features an IP65 rating including the PIR sensor making it the perfect choice for outdoor domestic security illumination.

PIR Models

PIR models include controls for sensitivity, time, lux levels and feature an 8-meter detection range with 120° monitoring angle.

Mounting Bracket

Featuring a quick install angled mounting bracket for ease of installation without the need to disassemble the fitting.

PIR Override Function

The Atlas Mini PIR models all feature PIR override. This allows the PIR models to function as standard floodlights if required.

35,000 HOUR LIFE	IK08 RATED
≥ 66lm/W EFFICIENCY	Cool White 4000K
IP65 RATED	110° BEAM ANGLE

Warranty

5 YEAR	Manufacturers Warranty
1 YEAR	On-Site Warranty



Applications

The Slim-line design and variety of wattages available make the Atlas Mini the perfect choice for providing lighting and assisting with security for homes and small business premises.

IP65 Rating

The Atlas Mini Slim-line Floodlight features an IP65 rating offering complete protection against contact dust and water.



Product Code	Watts (W)	Volts (V)	Colour Appearance	Colour Temp (K)	Useful Lumens (lm)	Total Lumens (lm)	Efficiency (lm/W)	Beam Angle	Dimensions (mm)			Order Qty
									W	H	D	
Standard - Single Carton												
12554	10	240	Cool White	4000	660	750	66lm/W	110°	127	102	26	1
12561	20	240	Cool White	4000	1350	1500	68lm/W	110°	159	121	28	1
12578	30	240	Cool White	4000	2090	2200	70lm/W	110°	197	145	29	1
12585	50	240	Cool White	4000	3290	4000	66lm/W	110°	243	178	32	1
PIR - Single Carton												
12592	10	240	Cool White	4000	660	750	66lm/W	110°	127	149	55	1
12608	20	240	Cool White	4000	1350	1500	68lm/W	110°	159	169	55	1
12615	30	240	Cool White	4000	2090	2200	70lm/W	110°	197	191	55	1
12622	50	240	Cool White	4000	3290	4000	66lm/W	110°	243	224	55	1

Includes override function - turn-on/off/on to override PIR.

Tel: 01274 657 088
 Email: sales@cromptonlamps.com
 Web: www.cromptonlamps.com



5 METRE LED FLEXI-STRIP LIGHTING



5 METRE FLEXI-STRIP KITS
PAGE 78



RGB

5 Metre RGB Flexi-Strip
IP65 Rated with Remote Control



COOL WHITE & WARM WHITE

5 Metre Flexi-Strip kit
Available in Warm White or Cool White



5M LED FLEXI-STRIP KITS

Available In RGB, Warm White and Cool White

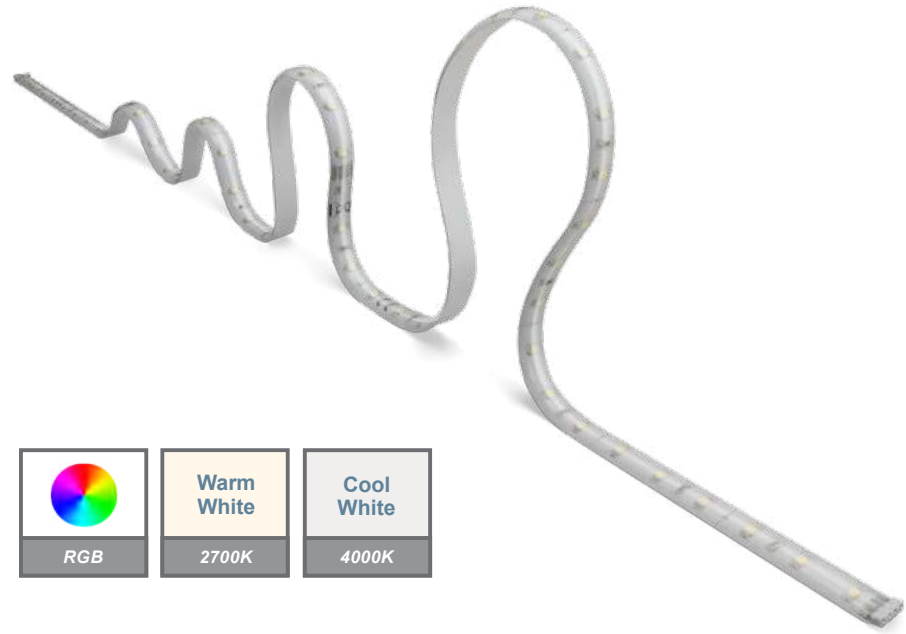

RGB Flexi-Strip



1 x IP65 5M LED Flexi-Strip Light RGB, 1 x IP20 AC power adapter with integrated UK plug, 1 x infrared remote control, 1 x infrared receiver, 2 x 10cm flexible connectors with clamp to both ends and 2 x straight connectors with clamps to both ends.

Warm White Flexi-Strip



1 x IP65 5M LED Flexi-Strip Light WW, 1 x IP20 AC power adapter with integrated UK plug, 2 x 10cm flexible connectors with clamp to both ends and 2 x straight connectors with clamps to both ends.

Cool White Flexi-Strip

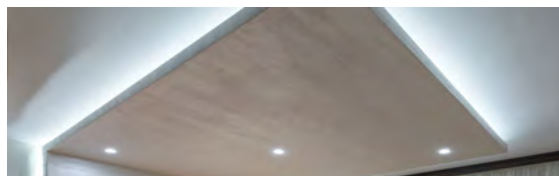

1 x IP65 5M LED Flexi-Strip Light CW, 1 x IP20 AC power adapter with integrated UK plug, 2 x 10cm flexible connectors with clamp to both ends and 2 x straight connectors with clamps to both ends.

Remote Control - RGB

The RGB Flexi-Strip Kit includes a remote control receiver for ease of use.

Dimmable - RGB

The RGB Flexi-Strip is dimmable via remote control and includes strobe and flash functions for added lighting effects.

IP65 Rated

The IP65 rating enables all strip kits in the range to be used both indoors or outdoors, adding extra versatility.

3M Backing

Thanks to the quality 3M backing, all strip kits can be attached to almost any surface, both indoors and outdoors.

Adaptable

All Flexi-Strip Lights in the range can be cut at regular intervals making them ideal for custom lighting applications.

30,000 HOUR LIFE	 RGB
 CLASS 2	Cool White 4000K
IP65 RATED	Warm White 2700K

Warranty

3 YEAR	Manufacturers Warranty
1 YEAR	On-Site Warranty



Applications

Flexi-Strips are ideal for a variety of both domestic and commercial lighting applications that include kitchens, stairs, bars, restaurants, and casinos. The IP65 rating adds further versatility for outdoor applications.

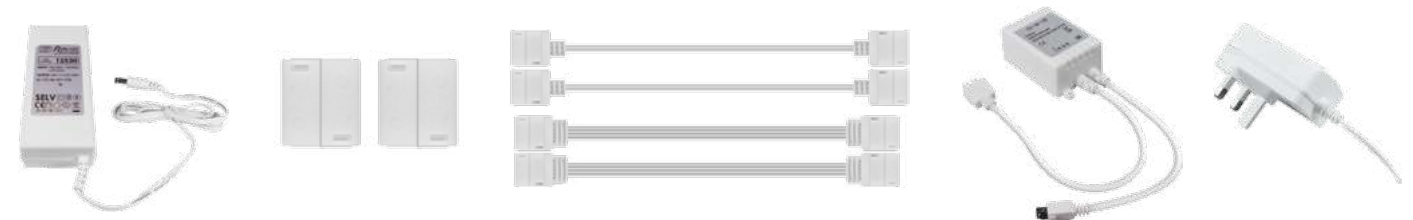

Product Code	Product Description	Watts (W)	Volts (V)	Colour Temp (K)	Total Lumens (lm)	Dimensions (mm)			Order Qty
						W	H	L	
RGB 5 Metre LED Flexi-Strip Light Kit - Blister Pack									
12516	5M LED RGB Flexi-Strip Kit	32	24	RGB		10	3	5000	1
	Contents: 1 x IP65 5M LED Flexi-Strip Light RGB, 1 x IP20 AC power adapter with integrated UK plug, 1 x infrared remote control, 1 x infrared receiver, 2 x 10cm flexible connectors with clamp to both ends and 2 x straight connectors with clamps to both ends								
12530	RGB Driver Kit	60	24						1
	Larger driver to support combined LED strips up to 10cm in length								
Warm White 5 Metre LED Flexi-Strip Light Kit - Blister Pack									
12493	5M LED Warm White Flexi-Strip Kit	20	24	2700	1800	8	3	5000	1
	Contents: 1 x IP65 5M LED Flexi-Strip Light WW, 1 x IP20 AC power adapter with integrated UK plug, 2 x 10cm flexible connectors with clamp to both ends and 2 x straight connectors with clamps to both ends								
12523	WW/CW Driver Kit	48	24						1
	Larger driver to support combined LED strips up to 10cm in length								
Cool White 5 Metre LED Flexi-Strip Light Kit - Blister Pack									
12509	5M LED Cool White Flexi-Strip Kit	20	24	4000	1900	8	3	5000	1
	Contents: 1 x IP65 5M LED Flexi-Strip Light CW, 1 x IP20 AC power adapter with integrated UK plug, 2 x 10cm flexible connectors with clamp to both ends and 2 x straight connectors with clamps to both ends								
12523	WW/CW Driver Kit	48	24						1
	Larger driver to support combined LED strips up to 10cm in length								
Accessories									
12547	Accessory Kit for LED Flexi-Strip (For re-connecting cut-off lengths of 5M Flexi-Strip Light)								1
	Contents: 2 x 15cm flexible connector with clamp to both ends (RGB), 2 x 2 straight connectors with clamps to both ends (RGB), 2 x 15cm flexible connector with clamp to both ends (CW/WW), 2 x 2 straight connectors with clamps to both ends (CW/WW)								

Tel: 01274 657 088
Email: sales@cromptonlamps.com
Web: www.cromptonlamps.com



NEXT GENERATION SMART LED LIGHTING



SMART LED GLS
PAGE 84



SMART LED CANDLE
PAGE 84



SMART LED GU10
PAGE 84

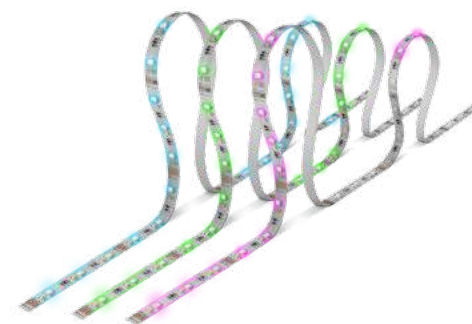

SMART LED FLEXI-STRIP
PAGE 84



SMART LED DOWNLIGHT
PAGE 22

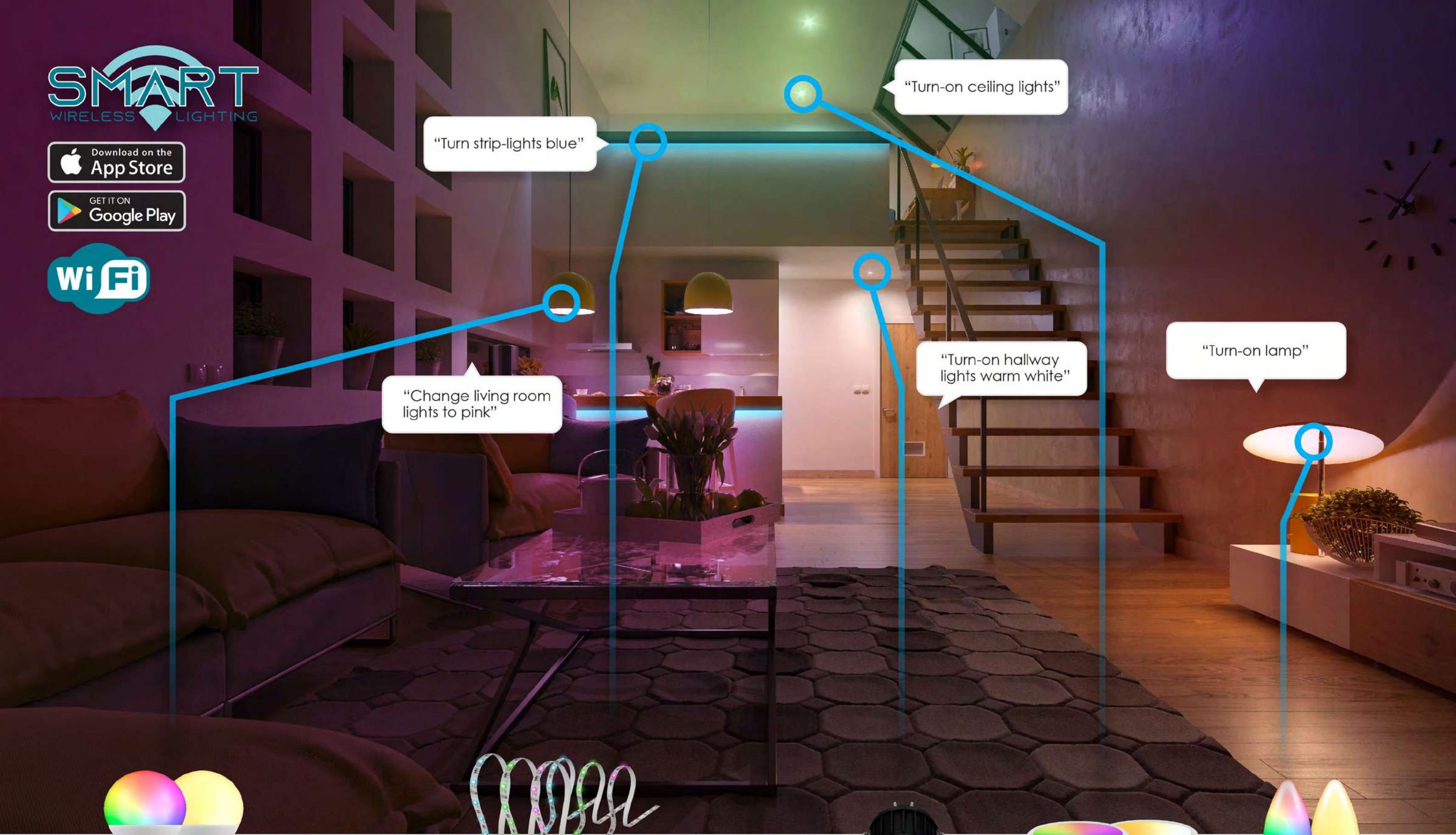

"Turn strip-lights blue"

"Turn-on ceiling lights"

"Change living room lights to pink"

"Turn-on hallway lights warm white"

"Turn-on lamp"



GLS



Flexi-Strip



Downlight



GU10



Candle

SMART LED LIGHTING

Voice and App Control Smart LED Lighting



Voice Control and App Control

Control lights with the touch of a screen or by voice command. Effortlessly instruct lights to turn-on/off, dim down, increase the brightness or change colour temperature.



Create Custom Lighting Schemes and Commands

Create and store custom lighting schemes and commands to be used when you need them. Create the perfect lighting for watching movies, reading books or working in the home office.



Easy Installation and No Extra Hub Required

Pair Smart Lights directly to a smart device without the need of an external hub. No external hub means no extra hardware costs and no extra installation steps simplifying the install process.

Requires WIFI 2.4 GHz 802.11b/g/n and Tuya app for set-up. Dimmable via voice control or app. Not compatible with a physical dimmer.

Complete Control

Control Smart Lights from anywhere via the Tuya app or compatible home hub.

Scheduled Lighting

Schedule Smart Lights to switch on/off individually or as part of a group at specific times when you're not home or in the mornings/evenings.

Group Lighting

Smart Lights allow users to control each lamp individually or as part of a group. The group feature allows lights to be grouped together and be controlled as one.

Smart Dimmable

The Smart Range are all dimmable via compatible smart app or voice control. Simply swipe the app or ask your home hub to dim or brighten lights to the desired level.

Colour Changing

The colour changing technology enables colours to be quickly changed with a finger swipe or voice command.



Warranty

3 YEAR Manufacturers Warranty

1 YEAR On-Site Warranty

SMART LED LIGHTING

Voice and App Control Smart LED Lighting

LED Dimmable Smart GLS

Product Code	Watts (W)	Volts (V)	Cap	Colour Appearance	Colour Temp (K)	Total Lumens (lm)	Incandescent Equivalent (W)	Dimensions (mm)		Energy Rating	Order Qty
								Dia	H		
GLS - Single Carton											
12301	8.5	240	BC-B22d	Warm White	3000	806	60	60	107	F	1
12318	8.5	240	ES-E27	Warm White	3000	806	60	60	107	F	1
12325	8.5	240	BC-B22d	RGB + Warm White	RGB + 3000	806	60	60	107	F	1
12332	8.5	240	ES-E27	RGB + Warm White	RGB + 3000	806	60	60	107	F	1

806 LUMENS		Warm White 3000K		15,000 HOUR LIFE		
----------------------	--	----------------------------	--	----------------------------	--	--

Dimmable via voice control or app. Not compatible with a physical dimmer.

LED Dimmable Smart Candle

Product Code	Watts (W)	Volts (V)	Cap	Colour Appearance	Colour Temp (K)	Total Lumens (lm)	Incandescent Equivalent (W)	Dimensions (mm)		Energy Rating	Order Qty
								Dia	H		
Candle - Single Carton											
12349	5	240	BC-B22d	Warm White	3000	470	40	37	108	F	1
12356	5	240	SES-E14	Warm White	3000	470	40	37	108	F	1
12363	5	240	BC-B22d	RGB + Warm White	RGB + 3000	470	40	39	114	F	1
12370	5	240	SES-E14	RGB + Warm White	RGB + 3000	470	40	39	114	F	1

470 LUMENS		Warm White 3000K		15,000 HOUR LIFE		
----------------------	--	----------------------------	--	----------------------------	--	--

Dimmable via voice control or app. Not compatible with a physical dimmer.

LED Dimmable Smart GU10

Product Code	Watts (W)	Volts (V)	Cap	Colour Appearance	Colour Temp (K)	Useful Lumens (lm)	Beam Angle	Halogen Equivalent (W)	Dimensions (mm)		Energy Rating	Order Qty
									Dia	H		
GU10 - Single Carton												
12387	5	240	GU10	Tuneable White	2700 - 4000	320	100°	50	50	58	G	1
12394-V2	5	240	GU10	RGB + Tuneable White	RGB + 3000	320	100°	50	50	58	G	1
12400	5	240	GU10	RGB + Cool White	RGB + 4000	320	100°	50	50	58	G	1

320 LUMENS		TUNEABLE WHITE	Warm White 3000K	Cool White 4000K		15,000 HOUR LIFE		
----------------------	--	-----------------------	----------------------------	----------------------------	--	----------------------------	--	--

Dimmable via voice control or app. Not compatible with a physical dimmer.

LED Dimmable Smart 5m Flexi-Strip Kit

Product Code	Watts (W)	Volts (V)	Colour Appearance	Colour Temp (K)	Total Lumens (lm)	Dimensions (mm)		Order Qty
						L	W	
5m Flexi-Strip Kit - Single Carton								
12417	18	240	RGB + Tuneable White	RGB + 2700 - 6500	1500	5000	12	1

1500 LUMENS		TUNEABLE WHITE		20,000 HOUR LIFE		
-----------------------	--	-----------------------	--	----------------------------	--	--

Kit contains:
1x 5 metre flexi-strip,
2x 15cm connecting leads,
1x power supply with integrated LED and UK plug,
1x WiFi controller box

Dimmable via voice control or app. Not compatible with a physical dimmer.

Tel: 01274 657 088

Email: sales@cromptonlamps.com

Web: www.cromptonlamps.com



KRIOS LED EMERGENCY LIGHTING RANGE



KRIOS BLADE
PAGE 90



KRIOS WALL BOX
PAGE 92



KRIOS BULKHEAD
PAGE 96



KRIOS SPOTLIGHT
PAGE 98



KRIOS TWIN SPOTLIGHT
PAGE 100



EMERGENCY BLADE

Krios Emergency Blade
Maintained or Non-maintained Functionality



EMERGENCY WALL BOX

Krios Emergency Wall Box
Maintained or Non-maintained Functionality



KRIOS EMERGENCY LED BLADE

Both Maintained or Non-Maintained Functions



Stylish, Robust and Reliable

With its robust build and 3-year life span, the Krios Emergency Blade combines style with safety and durability.

Mounting Options

The Krios Emergency Blade can be surface mounted to ceilings and walls or it can also be mounted perpendicular to a wall. Suspension and recessed mounting kits are available separately.

Sleek & Stylish

The stylish Krios Emergency Blade is ideal for modern workspaces.

Integrated Driver

The Krios Emergency Blade features a quality emergency driver with a LiFePO4 3.2 600mAh battery and 3-hour emergency run-time.

Maintained or Non-maintained

Having both maintained or non-maintained functions allows the Krios Emergency Blade to either be lit continuously or turn-on in the event of power failure.

ISO3864 Parts 1&3 Compliant Legend Set

The Krios Emergency Blade's ISO compliant Legend Set ensures that the signage has a clear and universal understanding.

Manual Test Function

The manual test function allows users to test the Krios Emergency Blade as and when required, in-line with testing regulations.

IP20

RATED

3 HOUR

EMERGENCY

Warranty

3 YEAR Manufacturers Warranty

1 YEAR On-Site Warranty



Applications

The slim and stylish Krios Emergency Blade is perfectly suited for corridor ceilings and walls in offices, hospitals, hotels, apartments and hospitality applications.

Down ISO Legend Set

Supplied with ISO3864 Parts 1&3 compliant Down Arrow Legend Set.

1 YEAR Emergency Battery Warranty



Up and Left/Right ISO Legend Set

ISO3864 Parts 1&3 Compliant Up and reversible Right/Left Legend Set available separately.



Product Code	Details	Watts (W)	Volts (V)	Dimensions (mm)			Order Qty
				W	H	D	
Single Carton							
14022	LED Emergency Blade	2	240	267	187	34	1
14039	Legend Set - Arrow Up			261	133		1
14046	Legend Set - Arrow Left/Right			261	133		1
14565	Suspension Kit						1
14572	Recessed Kit						1

Tel: 01274 657 088
 Email: sales@cromptonlamps.com
 Web: www.cromptonlamps.com



KRIOS EMERGENCY LED WALL BOX

Both Maintained or Non-Maintained Functions



Robust and Reliable

The Krios Wall Box features a robust steel construction with tough acrylic front panel making it extremely durable.



Rechargeable Battery

The Krios Emergency Wall Box is fitted with a high quality 3.6V 1.8Ah Ni-cd rechargeable battery.



1 YEAR Emergency Battery Warranty

IP20 Rated

The IP20 rating allows the Krios Emergency Wall Box to be used indoors.

Integrated Driver

The Krios Emergency Wall Box features a quality emergency driver with 1800mAh Ni-cd battery and 3-hour emergency run-time.

Maintained or Non-maintained

Having both maintained or non-maintained functions allows the Krios Emergency Wall Box to either be lit continuously or turn-on in the event of power failure.

EN60598-2-22:2015 Compliant

The Krios Emergency Wall Box complies with EN60589-2-22:2015 for emergency luminaires ensuring the highest safety standards.

26 Metre Visibility

The quality light output emitted ensures a 26-metre visibility range.

IP20

RATED

3 HOUR

EMERGENCY

Warranty

3 YEAR Manufacturers Warranty

1 YEAR On-Site Warranty

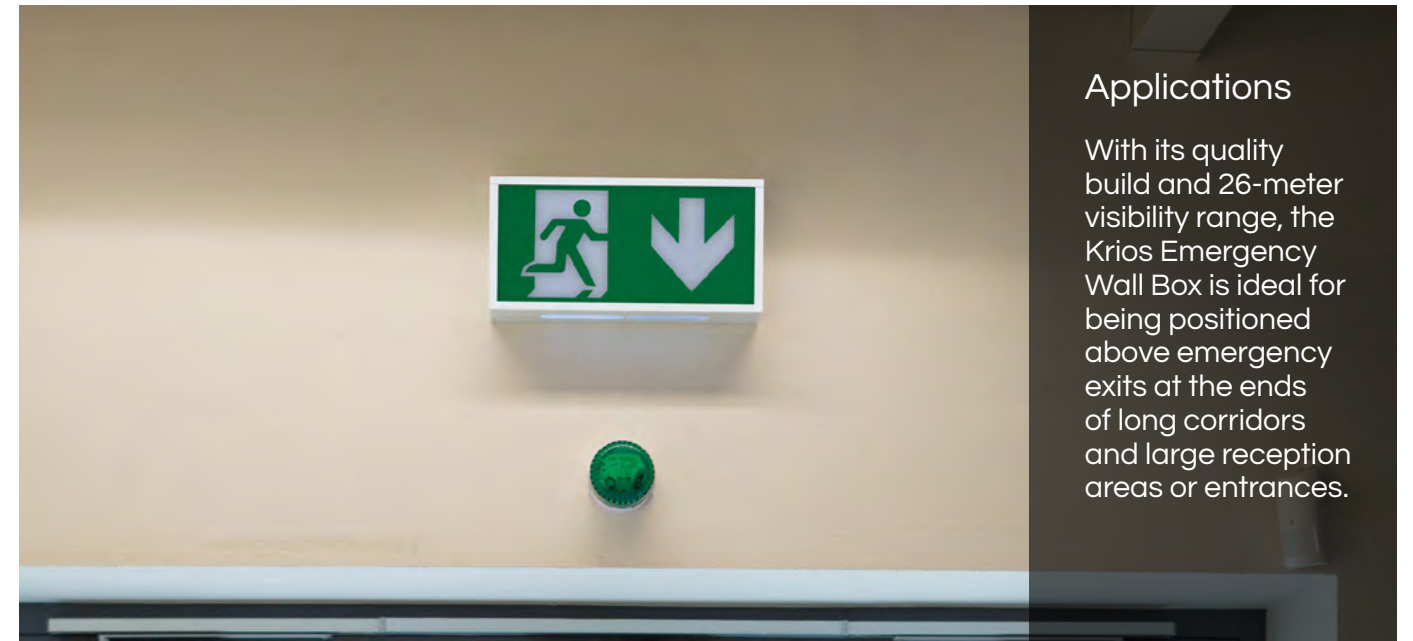

Applications

With its quality build and 26-metre visibility range, the Krios Emergency Wall Box is ideal for being positioned above emergency exits at the ends of long corridors and large reception areas or entrances.

ISO Legend Set

Supplied with Down Arrow Legend Set. Up, Right and Left Legend sets available separately.



Product Code	Details	Watts (W)	Volts (V)	Dimensions (mm)			Order Qty
				W	D	H	
Single Carton							
14060	LED Emergency Wall Box	1.8	240	390	62	190	1
14077	Legend Set - Arrow Up						1
14084	Legend Set - Arrow Left						1
14091	Legend Set - Arrow Right						1

Tel: 01274 657 088
 Email: sales@cromptonlamps.com
 Web: www.cromptonlamps.com





EMERGENCY BULKHEAD

Krios Emergency Bulkhead
IP65 Rated with Maintained or Non-maintained Functionality

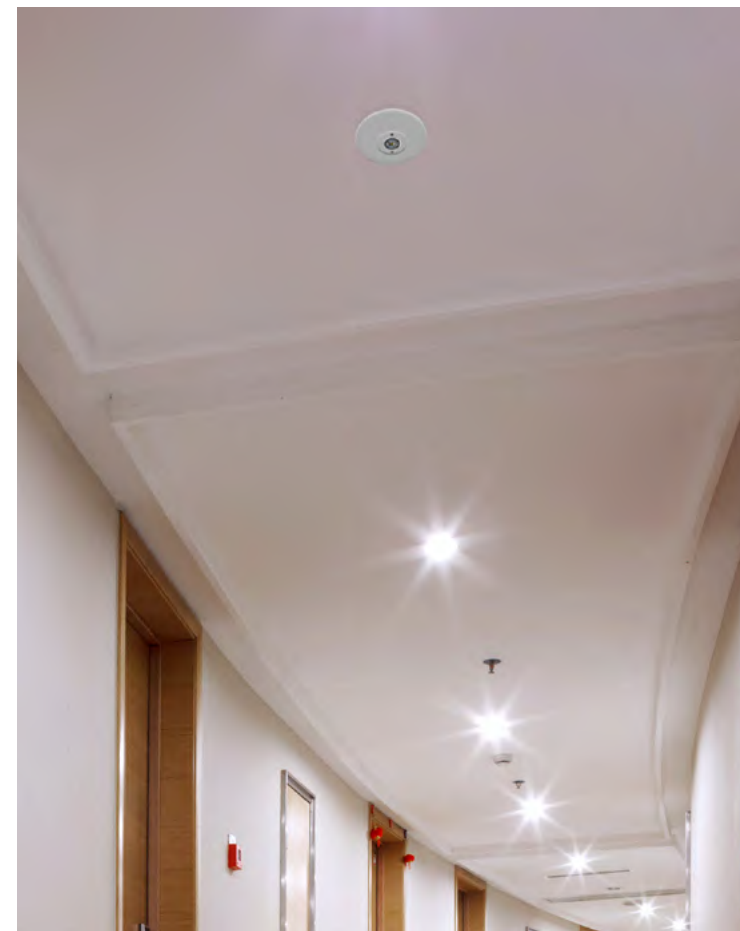

EMERGENCY SPOTLIGHT

Krios Emergency Spotlight
For Recessed Installations



EMERGENCY TWIN SPOT

Krios Emergency Twin Spotlight
IP65 Rated with Twin Light Output



KRIOS EMERGENCY LED BULKHEAD

IP65 Rated with 26 Metre Visibility



1 YEAR Emergency Battery Warranty



Indoor or Outdoor

The Krios Emergency Bulkhead offers great versatility due to the IP65 rating that allows it to be used both indoors and outdoors.

26 Metre Visibility

The quality light output emitted ensures a 26-metre visibility range.

Integrated Driver

The Krios Emergency Bulkhead features a quality emergency driver with 3.6V 1.0aH Ni-cd battery and 3-hour emergency run-time.

Maintained or Non-maintained

Having both maintained or non-maintained functions allows the Krios Emergency Bulkhead to either be lit continuously or turn-on in the event of power failure.

EN60598-2-22:2015 Compliant

The Krios Emergency Bulkhead complies with EN60589-2-22:2015 for emergency luminaires ensuring the highest safety standards.

IP65 Rating

The IP65 rating ensures that the Krios Emergency Bulkhead can be utilised both indoors or outdoors without issue.

IP65
RATED

3 HOUR
EMERGENCY

Warranty

3 YEAR Manufacturers Warranty

1 YEAR On-Site Warranty



Applications

The IP65 rating makes the Krios Emergency Bulkhead ideally suited for indoor and outdoor applications in offices, hospitals, workspaces and above exterior emergency exit doors.

Robust and Reliable

The Krios Emergency Bulkhead is EN60598-2-22:2015 compliant with a 26-metre visibility range and built from tough polycarbonate making it a safe and reliable choice.



Integrated Driver

Features an integrated emergency driver fitted with a rechargeable emergency battery and is backed by a 3-year lifespan.



ISO Legend Set

Supplied with Down, Up, Left and Right Arrow Legend Set.



Product Code	Details	Watts (W)	Volts (V)	Dimensions (mm)			Order Qty
				W	D	H	
Single Carton							
13971	LED Emergency Bulkhead	4	240	352	67	110	1

Tel: 01274 657 088
Email: sales@cromptonlamps.com
Web: www.cromptonlamps.com



KRIOS EMERGENCY LED SPOTLIGHT

Emergency Spotlight for Recessed Installations



Designed for recessed installations in open areas.

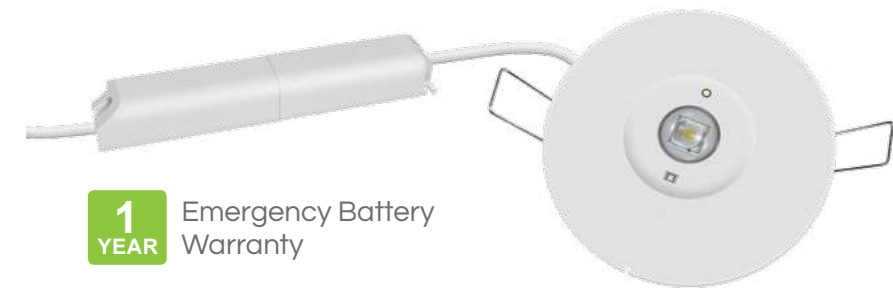

1 YEAR Emergency Battery Warranty

Featuring Integrated Driver

Emergency Spotlight for recessed installations featuring an integrated emergency driver, manual test function with LED indicator and rechargeable emergency battery.



Corridor Head (No Driver)

Non-Maintained replacement corridor head with a manual test function and LED indicator to be used with product code 14008. Ideal for narrow areas such as corridors and walkways.

IP20 Rated

The IP20 rating makes the Krios Emergency Spotlight suitable for indoor use.

Emergency Driver

The Krios Emergency Spotlight features a quality emergency driver with a LiFePO4 3.2V 1500mAh rechargeable battery.

Non-maintained

The non-maintained functionality ensures that the Krios Emergency Spotlight turns-on and emits light in the event of a power failure.

EN60598-2-22:2015 Compliant

The Krios Emergency Spotlight complies with EN60598-2-22:2015 for emergency luminaires ensuring the highest possible safety standards.

Manual Test Function

The manual test function allows users to test the Krios Emergency Spotlight as and when required in-line with testing regulations.

Corridor Head

Additional corridor head (No driver) also available separately for narrow areas and walkways. (To be used with product code 14008).



Warranty

- 3 YEAR** Manufacturers Warranty
- 1 YEAR** On-Site Warranty



Applications

The Krios Emergency Spotlight is the perfect solution when emergency lighting is required for recessed installations in open interior areas. The optional corridor is ideal for recessed installations in narrow walkways.

Round Lens

Position	Height	Distance
	2.8 m	11.2 m
	3 m	11.4 m
	4 m	12.1 m
	5 m	12.3 m
	6 m	11.9 m
	7 m	11 m
	2.8 m	4.5 m
	3 m	4.5 m
	4 m	4.5 m
	5 m	4.2 m
	6 m	3.4 m
	7 m	2.3 m

Dependable and Durable

The Krios Emergency LED Spotlight features a 3-year life span and 50,000 hour long-life maintenance-free operation.

Corridor Lens

Position Height	Corridor Head	Spotlight	Spotlight	Spotlight
2.8 m	0.9 m	7.1 m	2.2 m	20.8 m
3 m	0.9 m	7.1 m	2.2 m	21.4 m
4 m	0.9 m	7.2 m	2.4 m	19.8 m
5 m	1 m	5.9 m	3 m	20.6 m

Product Code	Details	Watts (W)	Volts (V)	Dimensions (mm)			Order Qty
				Dia	H	Cutout	
Single Carton							
14008	LED Emergency Spotlight	1	240	95	30	70	1
14015	Corridor Head (No Driver)	1	240	95	30	70	1

Tel: 01274 657 088
 Email: sales@cromptonlamps.com
 Web: www.cromptonlamps.com



KRIOS EMERGENCY LED TWIN SPOTLIGHT

IP65 Rated with Twin Light Outputs



IP65
RATED



Twin Adjustable Heads

The adjustable twin spotlights heads can be independently adjusted and moved to emit light in different directions.



IP65 Rated

The IP65 rating makes the Krios Twin Spotlight suitable for use both indoors and outdoors offering added versatility.

1 YEAR Emergency Battery Warranty

26 Metre Visibility

The quality light output emitted ensures a 26-metre visibility range.

Integrated Driver

The Krios Emergency Twin Spotlight features a quality emergency driver with 12V 1.5aH Ni-cd battery and 3-hour emergency run-time.

Non-maintained

The non-maintained functionality ensures that the Twin Spotlight turns-on and emits twin light outputs in the event of a power failure.

EN60598-2-22:2015 Compliant

The Krios Emergency Twin Spotlight complies with EN60589-2-22:2015 for emergency luminaires ensuring the highest safety standards.

IP65 Rating

The IP65 rating ensures that the Krios Emergency Twin Spotlight can be utilised both indoors or outdoors without issue.

IP65

RATED

3

HOUR

EMERGENCY

Warranty

3 YEAR Manufacturers Warranty

1 YEAR On-Site Warranty



Applications

The robust construction and IP65 rating make the twin spotlight ideally suited for indoor and outdoor applications where light needs to be emitted in different directions such as interior stair-wells or external walls.

Safe and Dependable

The Krios Emergency Twin Spotlight is EN60598-2-22:2015 compliant with a 26-meter visibility range making it a safe and reliable choice.



Product Code	Details	Watts (W)	Volts (V)	Total Lumens (lm)	Dimensions (mm)			Order Qty
					W	D	H	
Single Carton								
13995	LED Emergency Twin Spotlight	2.3	240	400	300	82	294	1

Tel: 01274 657 088
 Email: sales@cromptonlamps.com
 Web: www.cromptonlamps.com



COMMERCIAL & DOMESTIC LIGHTING CONTROLS



INTELLIGENT DIMMER
PAGE 106



SMART RELAY SWITCH
PAGE 108



INTELLIGENT DIMMER

Intelligent Dimmer Switch
Touch Sensitive Dimmer with Wi-Fi Control



SMART RELAY SWITCH

Smart Relay Switch
Wi-Fi Control On/Off Relay Switch



INTELLIGENT DIMMER SWITCH

Touch Sensitive Dimmer with Wi-Fi Control



App Control



Voice Control



Touch Control

The touch-sensitive dimmer provides traditional switch functionality.

Voice Control

Effortlessly use voice control to instruct lights to turn-on/off, dim down, increase brightness via a compatible home hub or the Tuya App.

App Control

Users can quickly and easily control lights by the touch of a screen via the world-leading Tuya Smart App.

LED Wattage

The Phoebe LED Intelligent Touch Dimmer Switch can support up-to 220W maximum of dimmable LED lamps.

Traditional Wattage

A key feature of the Intelligent Dimmer is the ability to turn traditional lamps into wi-fi controllable lamps. (Supports 300W maximum)



Warranty

5 YEAR Manufacturers Warranty

1 YEAR On-Site Warranty



Applications

Perfect for transforming current lighting circuits into smart controlled lighting with added traditional dimmer functionality the Intelligent Dimmer is ideal for homes, apartments and hospitality projects.

Touch Control



Product Code	Description	Dimensions (mm)				Order Qty
		W	H	D1	D2	
Single Carton						
14671	Intelligent Dimmer Switch	89	86	26	8.7	1

Not suitable for use with Smart Wi-Fi controlled lamps. Requires Tuya App and Wifi 2.4 GHz 802.11b/g/n for set-up.

Tel: 01274 657 088
 Email: sales@cromptonlamps.com
 Web: www.cromptonlamps.com



SMART RELAY SWITCH

Wi-fi Control On/Off Smart Relay Switch



The Phoebe LED Smart Relay Switch converts any existing lighting circuit to Wi-Fi controllable.

Maximum Loads
Incandescent Lamps = 600W
Fluorescent Lamps = 400W
LED Lamps = 400W



On/Off Wi-Fi Control

Convert any existing lighting circuit to Wi-Fi controllable.

Voice Control

Users can turn-on/off lamps with simple voice commands with voice control. Compatible with most smart home hubs.

App Control

Users can quickly and easily turn lights on or off by the touch of a screen via the world-leading Tuya Smart App.

Schedule Lighting

Schedule lights to switch on/off at specific times when you're not home or in the mornings/evenings via the Tuya Smart App.

Complete Control

Wi-Fi Smart Control allows users to control lights remotely whilst on the go from anywhere via their smart device.



Warranty

5 YEAR Manufacturers Warranty

1 YEAR On-Site Warranty



Applications

Perfect for transforming current lighting circuits into smart controlled lighting the Smart Relay Switch is ideal for homes, apartments and hospitality projects.



App Control

Users can quickly and easily instruct lights to turn-on/off with a touch of a screen via the world-leading Tuya Smart App.



Voice Control

Effortlessly use voice control to instruct lights to turn-on/off via a compatible home hub or the World-leading Tuya App.



Product Code	Description	Dimensions (mm)			Order Qty
		W	H	L	
Single Carton					
14664	Smart Relay Switch	39	24	88	1

Not suitable for use with Smart Wi-Fi controlled lamps.
Requires Tuya App and Wifi 2.4 GHz 802.11b/g/n for set-up.

Tel: 01274 657 088
Email: sales@cromptonlamps.com
Web: www.cromptonlamps.com



Crompton Lamps/Phoebe LED Limited Warranty

For individual warranty details, refer to the original product packaging, or visit our website, www.cromptonlamps.com

Terms & Conditions:

A lamp/luminaire is considered defective or faulty if either of the following occurs:

- It fails before the end of the Rated Life in hours stated on the product box.
- The lumens fall below 70% of the Lumens stated on the product box.

This warranty only covers products applied within 'intended' or 'normal use' as defined by:

- The operating conditions are in accordance with the information supplied on the packaging, the product or the Crompton Lamps/Phoebe LED website.
- The burning period must not exceed 4,000 hours per year.
- The ambient temperature never exceeds the operating temperature range of -20°C to 30°C unless otherwise stated on the packaging.
- The relative humidity (RH) in the installation doesn't exceed 80% RH, or exceed the IP rating of the lamp/luminaire if relevant.
- The lamp is operated in an open luminaire with a minimum of 10mm spacing around the body of the lamp with the exception of the cap.
- The lamp/luminaire is not subjected to more than the stated switching cycles on the packaging. Switching cycle is defined as the sequence of switching the lamp on and off at set intervals of 30 seconds.
- The electrical installation in which the lamp operates is not subjected to voltage fluctuations in a range exceeding 230V +/- 10%.

This warranty is supplementary to our published standard Terms & Conditions of Sale and is based on ERP performance criteria and lifetime calculations/verification from the user. The warranty is only available within the UK and Ireland. This warranty does not affect the statutory rights of the purchaser.

The warranty period starts from the date the products were purchased/invoiced prior to final installation. The faulty or defective product must be returned to Crompton Lamps along with the receipt and postage paid by the sender. The warranty covers a one for one replacement product if it fails within the warranty period. The company reserve the right to repair or offer a replacement to a similar or better performance at the company's discretion.

The company is not liable for any consequential loss or rectification costs in relation to this warranty, and does not include any removal or re-installation activities, labour costs or expenses. Crompton Lamps reserves the right to carry out an audit of the lighting installation and test the concerned lamps to determine the cause of failure & applicability of the Warranty. At the company's request, access shall be given to the installation in order to carry out the necessary quality inspections to determine the failure cause.

Crompton Lamps reserves the right to make the final decision on the validity of all warranty claims.

Exclusions:

This Warranty does not cover any of the following:

- Damage due to misuse or negligence.
- Failures caused by acts of God / Acts of Terrorism.
- Installations in violation of any applicable standard, code or instruction or incorrect voltage.

Conditions of Sale:

All goods supplied are subject to the company's general conditions of sale which are available on request.

Trade Descriptions:

All descriptions represent only particulars of the goods to which they apply and do not form part of any contract. Due to a policy of continuous development and improvement, Crompton Lamps Limited reserves the right to change the specification and performance data of the products listed without prior notice or public announcement.



ORDER



DESPATCH



RECEIVE



Carriage Paid Price

£195

Minimum order value of £195 for carriage paid delivery to UK mainland destinations.

Orders under £195 will be subject to a £10.00 small order charge.

Please contact our customer service team for minimum order values and delivery prices to non-UK mainland destinations.



Same Day Despatch

Order **Monday - Friday** before **4pm** for **Same Day** despatch*.

*We endeavour to despatch all orders received Monday - Friday before 4pm the same day.



Next Day Delivery

All UK mainland orders will be despatched by our **Next Day** delivery service*.

*95% of orders are delivered the next working day. For customers requiring guaranteed next working day delivery, an extra charge will be applied.

Please contact our customer service team for guaranteed next day delivery options and prices.

The above information does not include weekend delivery. Please contact our customer service team if you require a quotation for Saturday delivery.

Visit our website and view our full range of lamps and fittings
Benefits of signing up:

- Online ordering
- Check stock and prices
- View order history
- Detailed product information
- View our comprehensive range



Tel: 01274 657 088
Email: sales@cromptonlamps.com
Web: www.cromptonlamps.com





Crompton Lamps/Phoebe LED Commercial Lighting Solutions V1.1

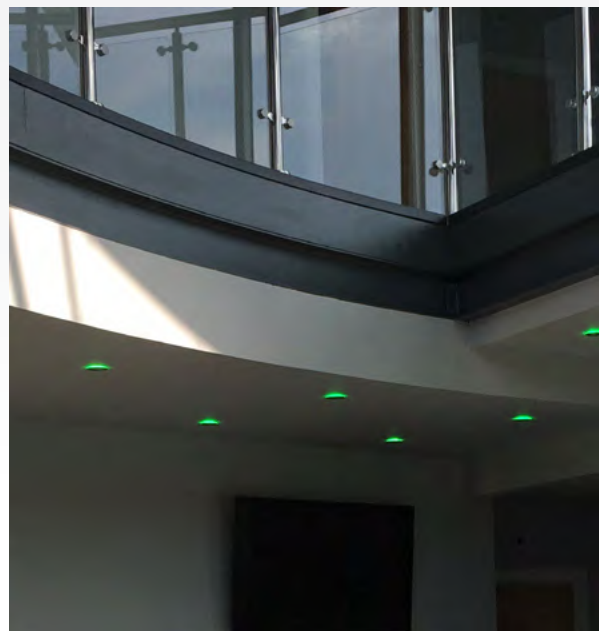

Crompton Lamps Limited registered in England and Wales No: 05590551

Crompton Lamps Limited
Unit 2
Marrtree Business Park
Bowling Back Lane
Bradford
BD4 8QE

Tel: 01274 657 088 Fax: 01274 657 087
Email: sales@cromptonlamps.com



www.cromptonlamps.com

Design and production by Marketing, Crompton Lamps Limited, E. & O. E. © Crompton Lamps Limited 2022. All rights reserved.

