

JC72503







Skydisc IP65

Skydisc IP65 17W 4000K 1700Lm

Features & Benefits

- Polycarbonate construction
- Triac dimmable as standard
- Low profile design ideal for use in shallow voids
- IP65 suitable for use in bathrooms (internal use only)



					
WARRANTY	CRI:RA	BEAM	RATING	DIMMABLE	CLASS II

General Information

Product Group	LED - Recessed
Product Range	Skydisc IP65
Trade Name	Skydisc
Light Source	LED
Light Source Features	Neutral White
Product Shape	Round
Additional Information	Not suitable for use with JCEM001ST
Mounting	Recessed
Product Weight	0.337kg
Color Finish	White
Overall Dimensions (mm) Rim	Ø220mm
Recommended Product Location	Indoor only
Method Of Fix	Spring Clips (supplied)
Product Aperture Size	210mm
IP Rating	IP65

Environment	Indoor
Suitable For Zones	Zone 1
Luminaire Accessories	Emergency remote pack JCEM001
Origin of manufacturer	Made In China
Warranty	2 years standard warranty extends to 3 years when registered within the first year of purchase (See Website for terms and conditions)
Dimming Protocol Compatibility	Triac
Driver Manufacturer	JCC
LED Manufacturer/Type	Runlite
Lighting Product Type 1	Downlight

Electrical

Voltage Rating	220-240
Secondary Running Current	240mA
Primary Running Current	0.14Amp
Operating Frequency Hz	50/60Hz
CC or CV	Constant current
Luminaire Circuit Wattage	17W
Class	Class II, double insulated no earth required
Output Voltage (V)	67.2-79.2VDC
EMC Compliant (EN55015)	Yes
Power Factor Correction	0.9
Input Electrical Connections	Live & Neutral: Class II, no Earth connection required.
Dimmable	Yes, Triac compatible

Thermals

Room Ambient Temperature Not To Exceed	30°C
Insulation Coverage	Do not cover with insulation

Performance Data

LED Life (Hours)	36000
Hours life stated is an indication of expected L70 chip and light output calculations when operating in optimum conditions. Product warranty period supports the full product during the term given. The L70 hours expectancy is not correlated with the full product warranty term, nor is it a representation of lumen depreciation during the warranty period.	
Energy Rating	This product contains a light source of energy efficiency class F
Actual Lumen Output	1700
Lumens Per Circuit Watt	100
Color Rendering Index	80-89
CRI: Ra	80
Correlated Color Temperature	4000K
Light Distribution Detail	120-degree

LOR (Light Output Ratio) %

100

Photometry Available

yes

Construction

Primary Material

Polycarbonate

Driver Housing

Polycarbonate

Packaging

Product Packaged Weight

0.44kg

Quantity Per Outer Carton

40

Product Bar Code EAN-13 Number

5052544080326

Standards & Approvals

Manufactured In Accordance To

BS EN 60598:2015, 2-1, 2-2

CE Marked

Yes

UKCA Marked

Yes

WEEE Symbol

Yes

Certificate Of Conformity

Yes: available on request.

Accredited Members

LIA, ISO9001:2015, ISO14001:2015

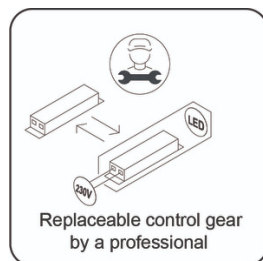
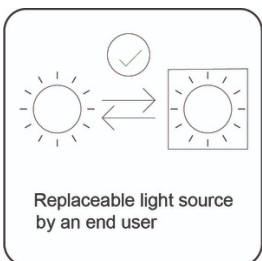
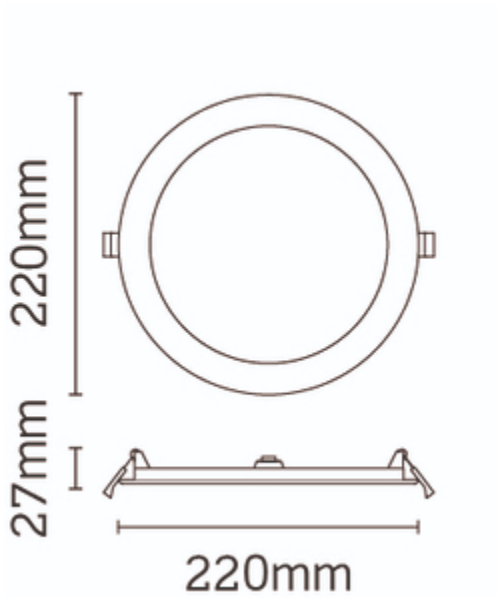



JCC Lighting LTD Innovation Centre, Beeding Close, Southern Cross Trading Estate, Bognor Regis, West Sussex PO22 9TS
Sales: 01243 838999 (8am to 5pm Monday to Friday) Fax: 01243 838998 | sales@jcc.co.uk | www.jcc.co.uk
Company Registration Number: 03044848 | VAT Number: 918544112

This document is uncontrolled if printed, all information is subject to change

Version 62 [23 Apr 2021]