



Commercial and
Domestic Light Fittings

Catalogue 2021

Lighting brilliance since 1878

www.cromptonlamps.com

Online ordering system and stock check

- All Phoebe LED fittings and Crompton Lamps products
- Live stock check
- Live customer prices
- Multiple purchasers can be set up for each account
- Cross-selling and alternative products
- Place orders on credit
- Quick order screen
- Upload CSV orders



To view our full range of innovative LED and Traditional Products visit

www.cromptonlamps.com



Contents

PHOEBE
LED

DOWNLIGHTS

Atlanta LED Universal Recessed or Surface Downlight.....	5
Spectrum LED Downlight with Bluetooth App Control	6
Spectrum Smart Switch	7
Firesafe Eco Fire-Rated LED Downlight	8
Firesafe All-in-One Fire-Rated LED Downlight	9

BULKHEADS

Melana LED CCT Bulkhead	10
Savocca LED CCT Internal Ceiling Light.....	12

PANELS

Galanos Arteson LED Back-Lit Panels with Emergency/UGR and TP(a) or TP(b) Options	13
--	----

BATTENS

Manto Non-Corrosive IP65 T8 Fittings	15
Manto Integrated 2 IP65 Luminaire with Emergency and Sensor Options..	16
Lykos IP65 Integrated CCT Battens with Emergency Option	17
Oracle IP20 Integrated CCT Battens with Emergency Option	18
Photius Integrated Luminaire with Emergency and Sensor Options.....	19

FLOODLIGHTS

Atlas-Mini LED Slimline Floodlight	20
Atlas LED Commercial Floodlight	21

Highbay

Keto LED Highbay	22
------------------------	----

Emergency Lighting

Krios Emergency Bulkhead.....	24
Krios Emergency Twin Spot.....	25
Krios Emergency Spot.....	26
Krios Emergency Blade.....	27
Krios Emergency Wall-Box	28

GARDEN

Terra LED Garden Spike.....	29
-----------------------------	----

DISPLAY

LED Mini Link-Light	30-31
LED Flexi Strip-Light	32
Electra Scoop Light.....	33
Phoebe Track - 3-Circuit universal Track System	34-37
Alecto LED Dimmable Track Spot-Light.....	38
Ares LED Track spot light.....	39

INTELLIGENT

Intelligent Dimmer Switch.....	40
--------------------------------	----

Smart Wireless Lighting Range

Firesafe SMART All-in-One Fire-Rated LED Downlight	42
LED SMART GLS	43
LED SMART Candle.....	44
LED SMART GU10	45
LED SMART 5m Flexi-Strip Kit	46



LED FILAMENT

LED Filament GLS Clear Dimmable	47
LED Filament Candle/Round Clear Dimmable & Non-Dimmable	48
LED Filament Bent-tip Candle Dimmable.....	49
LED Filament GLS Pearl Dimmable.....	50
LED Filament Candle/Round Pearl Dimmable & Non-Dimmable	51
LED Filament Antique Bronze Dimmable.....	52
LED Spiral Filament Antique Bronze Dimmable.....	53

LED THERMAL PLASTIC

LED GLS Thermal Plastic	54
LED GLS Thermal Plastic Dimmable.....	55
LED Candle Thermal Plastic	56
LED Candle Dimmable Thermal Plastic	57
LED Round Thermal Plastic	58
LED Round Dimmable Thermal Plastic.....	59
LED Reflector Thermal Plastic.....	60
LED 110V GLS Thermal Plastic	61
LED GLS Dusk till Dawn.....	62
LED Thermal Plastic Stick Lamp.....	63

LED COLOURED

LED Filament Coloured Harlequin GLS.....	64
LED Filament Coloured Harlequin Round.....	65
LED Coloured GU10	66
LED Coloured Sign.....	67
LED Coloured PAR38.....	68

LED PAR

LED PAR30 and PAR38 Dimmable	69
------------------------------------	----

LED GU10

LED Thermal Plastic GU10 SMD	70
LED Glass GU10 SMD Dimmable and Non-Dimmable	71
LED GU10 5W COB Dimmable and Non-Dimmable	72
LED GU10 Glass SMD 5.5W Sunset Dim	73
LED Long Barrel GU10 SMD	74

LED MR16/MR11

LED Glass 12V MR16 COB.....	75
LED 12V MR11 SMD	76

LED MINIATURES

LED Miniatures- Filament Cooker Hood and Pygmy/Sign/Fridge.....	77
LED 12V G4 Silicon, LED G9 Capsule and LED G9 Sunset Dim	78

LED RETROFIT

LED Linear R7s Lamps.....	79
LED PLL Direct to Mains.....	80
LED Double Ended Tubular	81
LED Dimmable AR111 includes LED Driver.....	82
LED AR111 12.5W Direct Retrofit and AR111 GU10 Direct to Mains.....	83
LED GX53.....	84
LED CC/2D Retrofit.....	85

LED TUBES

LED T8 Full Glass Tube.....	86
LED T8 Full Glass Tube with Foodsafe Shatterproof Coating	87
LED T5 Full Glass Tube.....	88
LED T5 Direct to Mains Full Glass Tube.....	89



Linear	90
G9 Capsule	91



T2 Ultra Mini Spiral	93
T4 Stick Lamp	94
Single Turn S Type (PL) 2 Pin.....	95
Single Turn S Type (PL) 4 Pin.....	96
Single Turn L Type (PLL)	97
Double Turn D Type (PLC)	98
Double Turn DE Type (PLC-E)	99
Triple Turn TE Type (PLT)	100
CC/2D	101



T5 Halophosphate.....	102
T5 Triphosphor	103
T8 Triphosphor	104
T8 Triphosphor Shatterproof	105
T9 Circular Triphosphor.....	106
Starter Switches	107



Ceramic Metal Halide	107
Double Ended Metal Halide	108
Elliptical Metal Halide for Open Luminaires	109
Metal Halide for Enclosed Luminaires.....	110
Dual Metal Halide for Enclosed Luminaires.....	111
High Output HPS (SON HO) Elliptical.....	112
High Output HPS (SON HO) Tubular	113
Single Ended Pulse Start Metal Halide Tubular	114



Craftlight GLS.....	115
Fireglow GLS and Candle	116
Infra Red Extended Life Reflector	117



Colourglazed GLS	118
Clear Sign.....	119
Colourglazed Sign.....	120
Colourglazed Round	121



Fridge.....	123
Oven.....	124
Microwave.....	125



Halogen - Important Circuit Information.....	126
Tables for Luminous Comparison	126
Icon Explanation	127
Crompton Lamps LED Warranty information	128
Index.....	129-135



**PHOEBE
LED**

4

Here at **PHOEBE LED** we are totally committed to bringing you first class, energy efficient, environmentally friendly, LED lighting products.

We utilise the very latest LED chips from the most reputable manufacturers in the world, the quality and efficiency of our design and production is focused on precise manufacturing consistency.

Simply cost effective, efficient, lighting products every time.

LED's dramatically reduce electrical running costs and carbon emissions converting up to 80% of energy into light.

As a cost-effective light source, LED's must also be considered for the massive reductions in maintenance costs over its lifetime (including labour and replacement of lamp costs as well as a reduction in disposal costs). Further savings can be made with a reduction of air conditioning costs due to the reduced heat emissions in most environments. LED's also emit minimal UV light at the same time.

Having over 20 years' experience in the LED market our team are focused on producing a product that has thermal design at the heart of its performance and is totally compliant to the current relevant standards for our markets. So you can be sure that **PHOEBE LED** products will enhance your future projects.

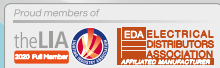

ATLANTA LED DOWNLIGHT

PHOEBE
LED

Energy efficient integrated LED downlight with an adjustable-width bracket to fit a range of existing cut-out installations.

- 30,000 hours rated life
- 50,000 switching cycles
- Constructed from TP(b) rated corrosion resistant thermal plastic and corrosion resistant PS diffuser
- Complies with Building Regulations B2
- Dimmable or non-dimmable
- 3000K warm white or 4000K cool white colour temperatures
- 120° beam angle
- Includes 25cm cable pre-wired to input
- Instant full light
- Surface mount or recessed installation
- IP20 rated for indoor use only



Recessed Installations: Adjustable Bracket to Fit Existing 2.5" to 8" Cutouts

Surface Mounted Installation

5

Product Code	Watts (W)	Volts (V)	Colour Appearance	Colour Temp (K)	Total Lumens (lm)	Beam Angle	Dimensions (mm)			Order Qty
							Dia	H	Cutout Ø	
Non-Dimmable - Single Carton										
10536	18.5	240	Warm White	3000	1550	120°	230	15	63.5 - 203	1
10543	18.5	240	Cool White	4000	1600	120°	230	15	63.5 - 203	1
Dimmable - Single Carton										
12172	6.5	240	Warm White	3000	440	120°	120	15	65 - 102	1
12189	6.5	240	Cool White	4000	460	120°	120	15	65 - 102	1
12196	18.5	240	Warm White	3000	1550	120°	230	15	63.5 - 203	1
12202	18.5	240	Cool White	4000	1600	120°	230	15	63.5 - 203	1

This product is compatible with most dimmer switches, please refer to website for up-to-date list of compatible dimmer switches.

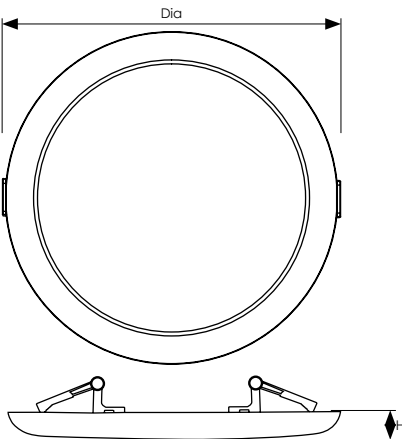

Emergency Packs coming soon, call the sales office for more details



**PHOEBE
LED**

Spectrum LED Downlight with Bluetooth App Control



RGB Colour Changing Rim

Mains operated fire rated* energy efficient integrated LED downlight, with tuneable white spotlight and RGB colour changing ambient halolight.

- 50,000 hours long life maintenance free operation
- 100,000 switching cycles
- Twin light outputs can be used together or independently
- Download the Phoebe LED Spectrum control app from Google Play or Apple App Store
- Fully dimmable spotlight tuneable from 2200K extra warm white to 6500K daylight colour temperature
- 30, 60 & 90 minute fire rated - Fully compliant and certified to BS476 Parts 21 and 22*
- Full spectrum RGB dimmable halolight with selectable colour or fast/slow cycle through colours options
- IP65 rated, suitable for outdoor use
- Uses Bluetooth Low Energy (BLE)
- Instant full light

6

Product Code	Description	Watts (W)	Volts (V)	Colour Appearance Inner/Outer	Colour Temp (K)	Useful Lumens (lm)	Total Lumens (lm)	Beam Angle	Dimensions (mm) Dia H Cutout ø	Order Qty
Single Carton										
9417	RGB Halo	10	240	CCT/RGB	2200-6500	650	890	40°	80 55 67-70	1
Accessories Single Carton										
10505	Gloss Black Bezel								80	1
10512	Antique Brass Bezel								80	1

Supplied with a toolless loop-in/loop-out quick connector. * Part L Compliant of UK Building Regulations. Part B Compliant BS476 Parts 21 and 22. Suitable for 30 minute 600mm/15mm single layer standard wallboard, 60 minute 600mm/12.5mm twin layer fireboard and 90 minute 450mm/15mm twin layer fireboard ceilings.



Supplied with White, Chrome and Brushed Aluminium bezels with magnetic fastener for quick removal/change
Gloss Black and Antique Bronze bezels available separately

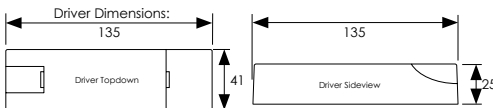
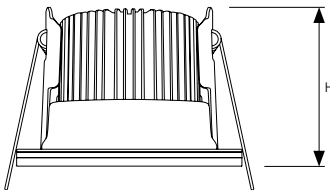



Spectrum Smart Switch



Touch sensitive smart control switch for the Spectrum range of smart device controlled downlights. Ideal for wall control without the need to use any of your paired smart devices. Gives traditional functionality and convenience of a wall-mounted switch to your Spectrum downlights.

- Independent main light and halo light control
- Full colour and brightness control
- Touch-sensitive controls
- Wireless Bluetooth signalling to light group
- Supports a single group of up to 20x Spectrum downlights
- Switch requires an AC neutral In feed from the lighting circuit (see wiring diagram)



Product Code	Volts (V)	Dimensions (mm)					Order Qty
		W	H	D ¹	D ²	D ³	
Single Carton							
10420	240	85	85	6	31	37	1

For use with Spectrum LED Downlights.
Maximum load 200W: Supports up to 20x Spectrum Downlights



Smart device and App required for initial setup.



Wiring Diagram

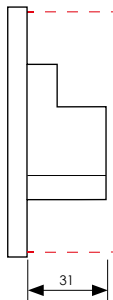
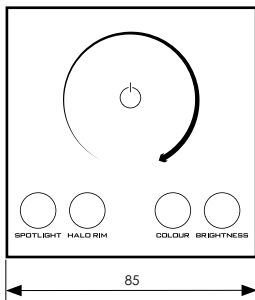
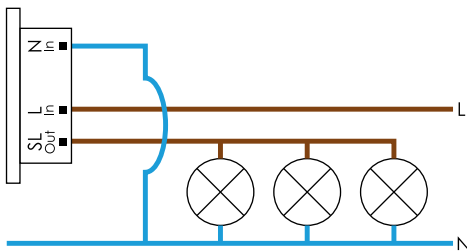

Fits in a standard 35mm back box



NEW



Fire rated energy efficient integrated LED downlight.

- 30,000 hours long life maintenance free operation
- 30, 60 & 90 minute fire rated - Fully compliant and certified to BS476 Parts 21 and 22
- Available in 3000K warm white and 4000K cool white colour temperature
- Dimmable - DuoDim™ Technology compatible with both leading and trailing edge dimmers*
- Driver housing away from main body to maximise ventilation and prevent heat build-up to prolong life
- Features tool-less loop-in/loop-out quick-connector for fast and easy installation
- Supplied with white and Satin Nickel quick change bezels
- Polished Chrome Bezel available separately
- IP65 rated
- Constructed from die-cast aluminium
- Instant full light

Product Code	Watts (W)	Volts (V)	Colour Appearance	Colour Temp (K)	Useful Lumens (lm)	Total Lumens (lm)	Beam Angle	Dimensions (mm)				Order Qty
								Dia	H	W	Cutout ø	
Single Carton												
12868	6.7	240	Warm White	3000	470	540	60°	88	90	100	70-72	1
12875	6.7	240	Cool White	4000	490	560	60°	88	90	100	70-72	1
12646-10	Polished Chrome Bezel for Firesafe Downlights - PK of 10				-	-	-	88	5	-	-	1

Supplied with a tool-less loop-in/loop-out quick connector. Installation may require advice from a qualified person. Part L Compliant of UK Building Regulations, Part B Compliant BS476 Parts 21 and 22. Suitable for 30 minute 600mm/15mm single layer Standard Wallboard, 60 minute 600mm/12.5mm twin layer Fireboard and 90 minute 450mm/15mm twin layer Fireboard ceilings.

* This product is compatible with most dimmer switches, please refer to dimming compatibility sheet for up-to-date list of compatible dimmer switches.



Polished Chrome Bezel available separately

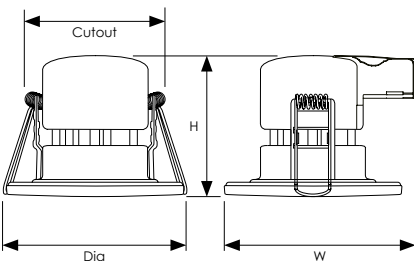

FIRESAFE LED DOWNLIGHT

PHOEBE
LED

Fire rated energy efficient integrated LED downlight with tri-colour selection-switch for use in a variety of applications.

- 50,000 hours long life maintenance free operation
- 30, 60 & 90 minute fire rated - Fully compliant and certified to BS476 Parts 21 and 22
- Tri-colour selection-switch under front bezel to quickly and easily set to either 3000K warm white, 4000K cool white or 6500K daylight colour temperature
- Dimmable - DuoDim™ Technology compatible with both leading and trailing edge dimmers*
- Features insulation guards for added ventilation and safety to prevent the Firesafe from being covered by insulation material
- Supplied with separate tool-less loop-in/loop-out constant current driver for quick and easy installation
- Includes 2x quick change bezels in White and Satin Nickel, polished chrome bezel available separately
- IP65 rated
- Constructed from die-cast aluminium
- Instant full light



9

Product Code	Watts (W)	Volts (V)	Colour Appearance	Colour Temp (K)	Useful Lumens (lm)	Total Lumens (lm)	Beam Angle	Dimensions (mm)			Order Qty	
								Dia	H	Cutout ø		
Single Carton												
12639	8.5	240	Warm/Cool/Daylight	3000/4000/6500	650	700	60°	89	65	70-72	1	
12646-10			Polished Chrome Bezel - 10 Pack			-	-	-	89	5	-	1

Supplied with a tool-less loop-in/loop-out quick connector. Installation may require advice from a qualified person. Part L Compliant of UK Building Regulations. Part B Compliant BS476 Parts 21 and 22. Suitable for 30 minute 600mm/15mm single layer Standard Wallboard, 60 minute 600mm/12.5mm twin layer Fireboard and 90 minute 450mm/15mm twin layer Fireboard ceilings.

* This product is compatible with most dimmer switches, please refer to dimming compatibility sheet for up-to-date list of compatible dimmer switches.

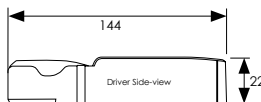
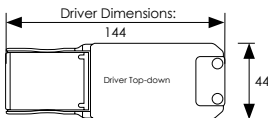
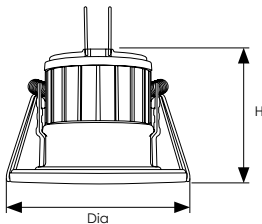

SMART SMART Wi-Fi
Version available
see page 42





11W 1000lm 15W 1500lm Dual Wattage Selection



Energy efficient integrated CCT LED round bulkhead with dual wattage selection.

- Dual wattage selection switch
- 1000lm total lumens at 11W 1500lm total lumens at 15W
- IP65 rated suitable for outdoor use
- Tri-colour select: 3000K warm white, 4000K cool white and 6500K daylight colour options
- Flicker Free Illumination
- Built-in safety isolating control gear with short circuit protection
- Toolless terminal block with loop-in loop-out function
- Long life 35,000 hours maintenance free operation
- Side conduit entry or rear entry compatible with 68/78mm junction box
- White finish with opal diffuser
- Tough polycarbonate IK10 impact rating
- Tamper resistant anti-vandal security screw
- Not suitable for dimming

10

Optional covers available

Part Number: **14688** Part Number: **14695**



Eyelid cover
Ideal anti-glare solution for Stairwells and other low wall mounted areas



Grille Cover
Decorative option

Emergency Models

- Integrated 3-hour emergency function

Sensor Models

- Built-in Microwave Sensor: with variable detection, hold-time, daylight threshold, stand-by timer and dimming level

Product Code	Watts (W)	Volts (V)	Colour Temp (K)	Total Lumens @11W (lm)	Total Lumens @15W (lm)	Beam Angle	Dimensions (mm)		Order Qty
							Dia	H	
Standard - Single Carton									
14145	15	240	3000/4000/6500	1000	1500	120°	300	85	1
Microwave Sensor* - Single Carton									
14152	15	240	3000/4000/6500	1000	1500	120°	300	85	1
3 Hour Emergency** - Single Carton									
14169	15	240	3000/4000/6500	1000	1500	120°	300	85	1
Microwave Sensor* and 3 Hour Emergency** - Single Carton									
14176	15	240	3000/4000/6500		1300	120°	300	85	1
Optional Eyelid Cover - Single Carton									
14688	-	-	-	-	-	-	300	-	1
Optional Grille Cover - Single Carton									
14695	-	-	-	-	-	-	300	-	1

* Microwave sensor with variable range, hold time, daylight threshold, stand-by period and stand-by dimming level.

** Charging time 24hrs - Running time 3hrs at reduced output.

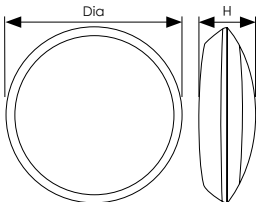

Battery Warranty

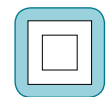



CROMPTON LAMPS LED SMART LIGHTING RANGE

Smart Wireless Lighting Compatible with Smart Devices and Home Hubs

- App and voice control
- Custom lighting schemes
- Control smart lights from anywhere
- Scheduled smart lighting
- Colour changing technology
- Smart dimmable and group lighting

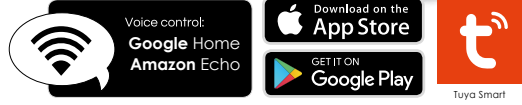

Compatible with most smart home hubs including Amazon Echo and Google Home

Android or Apple smart device required for set-up using Tuya Smart App. Tuya Smart App and wifi 2.4GHz 802.11b/g/n required for set-up.

No external hub/bridge required



View our full range of innovative LED Products

www.cromptonlamps.com





SAVOCA

LED INTERNAL CEILING LIGHT



12

Energy efficient integrated CCT LED internal ceiling light

- 12W 1000lm total lumens, 18W 1800lm total lumens
- Tri-colour select: 3000K warm white, 4000K cool white and 6500K daylight colour options
- Flicker free illumination
- Built-in safety isolating control gear with short circuit protection
- Toolless terminal block with loop-in loop-out function
- Long life 35,000 hours maintenance free operation
- White finish with opal diffuser
- Tough polycarbonate construction IK10 impact rating
- IP65 rated suitable for damp and humid conditions
- Recommended for indoor use
- Not suitable for dimming

Emergency Models

- Integrated 3-hour emergency function

Sensor Models

- Built-in Microwave Sensor: with variable detection, hold-time, daylight threshold, stand-by timer and dimming level

Product Code	Watts (W)	Volts (V)	Colour Temp (K)	Total Lumens (lm)	Beam Angle	Dimensions (mm)		Order Qty
						Dia	H	
Standard - Single Carton								
14589	12	240	3000/4000/6500	1000	120°	300	59	1
14626	18	240	3000/4000/6500	1800	120°	300	59	1
Microwave Sensor* - Single Carton								
14596	12	240	3000/4000/6500	1000	120°	300	59	1
14633	18	240	3000/4000/6500	1800	120°	300	59	1
3 Hour Emergency** - Single Carton								
14602	12	240	3000/4000/6500	1000	120°	300	59	1
14640	18	240	3000/4000/6500	1800	120°	300	59	1
Microwave Sensor* and 3 Hour Emergency** - Single Carton								
14619	12	240	3000/4000/6500	1000	120°	300	59	1
14657	18	240	3000/4000/6500	1800	120°	300	59	1

* Microwave sensor with variable range, hold time, daylight threshold, stand-by period and stand-by dimming level.

** Charging time 24hrs - Running time 3hrs at reduced output.

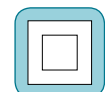
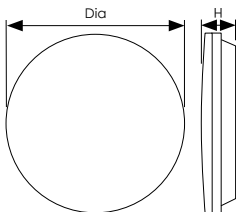

Battery Warranty

LED GALANOS ARTESON

PHOEBE LED

NEW

Energy efficient 600x600 and 1200x300 LED Backlit Panels.

- Available with TP(a) and TP(b) rated polycarbonate diffusers
- UGR<19 low glare option (600x600) TP(a)
- Energy efficient LED backlit technology
- 30,000 hour long life maintenance free operation
- 60,000 switching cycles
- Constructed from aluminium frame and housing with polycarbonate diffuser
- -20° to 40° operating temperature
- IP20 rated for indoor use only
- Instant full light
- Not suitable for dimming

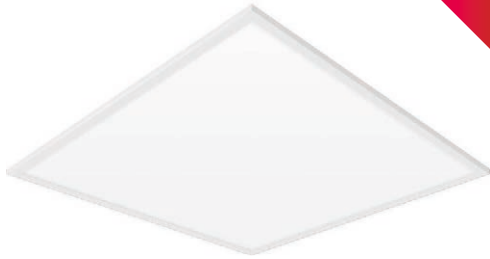

13

3-hour Emergency kit

- 3-hour emergency function conversion kit
- LED charge indicator
- Built-in NiMH battery for safe, stable and long lasting operation (3 year warranty)

Product Code	Watts (W)	Volts (V)	Product Description	Colour Temp (K)	Total Lumens (lm)	Beam Angle	Dimensions (mm)			Order Qty
							W	L	D	
Standard - Single Carton										
14473	40	240	TP(b) 600x600 Backlit Panel	3000	3200	110°	595	595	30	1
14480	40	240	TP(b) 600x600 Backlit Panel	4000	3200	110°	595	595	30	1
14497	40	240	TP(b) 600x600 Backlit Panel	6000	3200	110°	595	595	30	1
14121	38	240	TP(a) UGR<19 600x600 Backlit Panel	3000	3800	110°	595	595	30	1
14138	38	240	TP(a) UGR<19 600x600 Backlit Panel	4000	3800	110°	595	595	30	1
14503	40	240	TP(a) 1200x300 Backlit Panel	4000	3200	110°	295	1195	30	1
14510	Wire suspension kit for use with Galanos Arteson Panel						50 to 950mm drop			1
14527	3-hour emergency kit for use with Galanos Arteson Panel						73	212	28	1
14534	600x600 surface mounting kit for use with Galanos Arteson Panel						600	600	65	1
14541	1200x300 surface mounting kit for use with Galanos Arteson Panel						300	1200	65	1

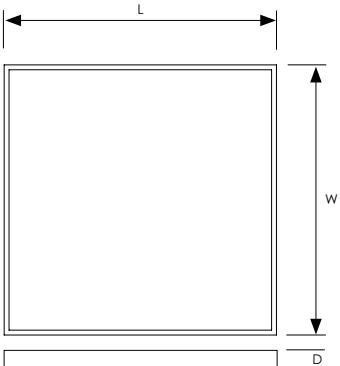

1 YEAR ON-SITE WARRANTY

5 YEAR LIMITED WARRANTY

3 YEAR BATTERY WARRANTY

UGR<19 Low Glare Rating

IP20 IP Rating

Grompton
LAMPS

14



320° diffused light

Direct retrofit for magnetic ballasts using included LED starter

40,000 hours

Warm White, Cool white and Daylight colour temperatures

No mercury or hazardous materials

Single ended circuit for risk free installation



LED FULL GLASS T8 TUBES

See pages
86-87

Lighting brilliance since 1878

IP65 fittings with anti-vandal stainless steel clips pre-wired to mains (240V) for use with Crompton Lamps LED T8 tubes only. For use in industrial, garage, workshop and food preparation applications. Suitable for conduit, surface or suspension mounting.

- Fused terminal block for safety
- IP65 rated - Suitable for outdoor use
- IK10 impact rating
- Standard 4ft/5ft or 6ft T8 lengths
- Single or twin 5ft and 6ft
- Moisture and acid resistance ABS body
- Polycarbonate diffuser
- Grade 316 tamper resistant stainless steel clips
- Continuous non-ageing gasket
- Only suitable for Crompton Lamps LED T8 tubes
- Not suitable for fluorescent T8 tubes as no control gear included



15

Product Code	Product Description	Compatible LED T8 Tubes			Dimensions (mm)			Order Qty
		Warm White	Cool White	Daylight	W	H	L	
Single Carton								
10611	Non-Corrosive IP65 4ft Single T8 Batten	LFT422WW	LFT422CW	LFT422DL	94	98	1265	1
5228	Non-Corrosive IP65 5ft Single T8 Batten	LFT524WW	LFT524CW	LFT524DL	94	98	1565	1
5235	Non-Corrosive IP65 6ft Single T8 Batten	N/A	LFT628CW	LFT628DL	94	98	1835	1
5242	Non-Corrosive IP65 5ft Twin T8 Batten	LFT524WW	LFT524CW	LFT524DL	138	97	1565	1
5259	Non-Corrosive IP65 6ft Twin T8 Batten	N/A	LFT628CW	LFT628DL	138	97	1835	1
Accessories								
5532	Stainless Steel Spare Clip Pack 5ft							1
5549	Stainless Steel Spare Clip Pack 6ft							1

See pages 86-87 for LED T8 Tubes.

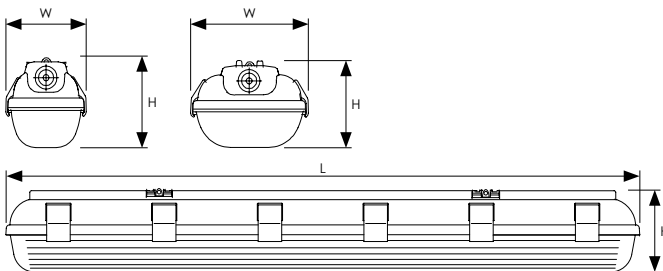

IP65 integrated fittings for use in industrial, garage, workshop and food preparation applications

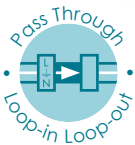
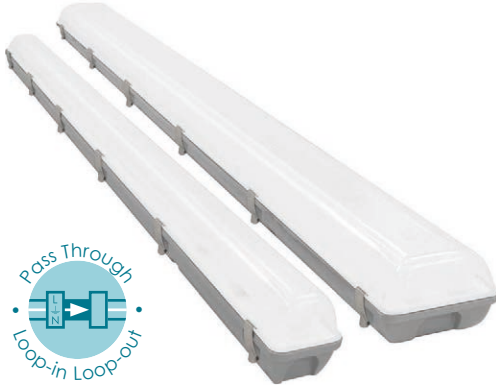

- 50,000 hour long life
- 15,000 switching cycles
- Suitable for conduit, surface, or suspension mounting
- Constructed from tough IK07 impact rated, moisture and acid resistant ABS body with Polycarbonate diffuser
- IP65 rated for wet weather outdoor use
- Pre-wired with continuous pass-through loop-in loop-out terminal blocks including permanent live for use with emergency models
- 3 hour emergency function*
- Microwave sensor with variable detection range, hold time and lux sensors**

Product Code	Product Description	Watts (W)	Volts (V)	Colour Temp (K)	Total Lumens (lm)	Beam Angle	Dimensions (mm)			Order Qty
							W	H	L	
4ft Standard - Single Carton										
11038	4ft with Microwave Sensor	20	240	4000	2000	120°	85	75	1270	1
11045	4ft with 3-Hour Emergency	20	240	4000	2000	120°	85	75	1270	1
4ft High Output - Single Carton										
11069	4ft with Microwave Sensor	40	240	4000	4000	120°	118	75	1270	1
11076	4ft with 3-Hour Emergency	40	240	4000	4000	120°	118	75	1270	1
5ft Standard - Single Carton										
11090	5ft Single with Microwave Sensor	30	240	4000	3000	120°	85	75	1570	1
11106	5ft Single with 3-Hour Emergency	30	240	4000	3000	120°	85	75	1570	1
5ft High Output - Single Carton										
11120	5ft with Microwave Sensor	60	240	4000	6000	120°	118	75	1570	1
11137	5ft with 3-Hour Emergency	60	240	4000	6000	120°	118	75	1570	1

* EM Discharge ≥ 3 Hours, 24 hour charge time required.

** 5m - 10m Detection range, 5secs - 10min Hold time, 2-2000lum Light sensitivity, Light output dims to 10% when sensor not triggered.

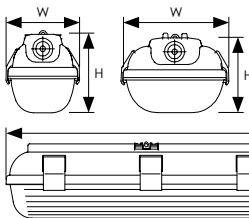

LYKOS

INTEGRATED CCT

PHOEBE
LED

IP65 integrated fittings for use in industrial, garage, workshop and food preparation applications

- Suitable for conduit, surface, or suspension mounting
- Constructed from tough IK08 impact rated, moisture and acid resistant Polycarbonate body and diffuser
- IP65 rated for wet weather outdoor use
- 3000K/4000K/5700K Tri-Colour Select
- Pre-wired with tooless spade terminals with pass-through loop-in loop-out including permanent live for use with emergency models
- 50,000 hour long life
- 100,000 switching cycles
- 120° beam angle
- Colour rendering index ≥ 80
- Ambient operating temp. -20°C to 40°C (0°C to 40°C for Emergency versions)
- Available with 3 hour emergency function*

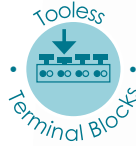

NEW



17

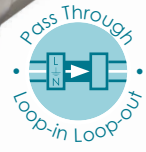

Product Code	Product Description	Watts (W)	Volts (V)	Colour Temp (K)	Total Lumens (lm)	Beam Angle	Dimensions (mm)			Order Qty
							W	H	L	
Standard - Single Carton										
14251	4ft Batten	20	240	3000K/4000K/5700K	2000	120°	80	72	1200	1
14275	5ft Batten	30	240	3000K/4000K/5700K	3000	120°	80	72	1500	1
Emergency - Single Carton										
14268	4ft Batten with 3-Hour Emergency	20	240	3000K/4000K/5700K	2000	120°	80	72	1200	1
14282	5ft Batten with 3-Hour Emergency	30	240	3000K/4000K/5700K	3000	120°	80	72	1500	1
High Output - Single Carton										
14299	High Output (HO) 4ft Batten	40	240	3000K/4000K/5700K	4000	120°	105	87	1200	1
14312	High Output (HO) 5ft Batten	60	240	3000K/4000K/5700K	6000	120°	105	87	1500	1
14336	High Output (HO) 6ft Batten	80	240	3000K/4000K/5700K	8000	120°	105	87	1800	1
Emergency High Output - Single Carton										
14305	HO 4ft Batten with 3-Hour Emergency	40	240	3000K/4000K/5700K	4000	120°	105	87	1200	1
14329	HO 5ft Batten with 3-Hour Emergency	60	240	3000K/4000K/5700K	6000	120°	105	87	1500	1
14343	HO 6ft Batten with 3-Hour Emergency	80	240	3000K/4000K/5700K	8000	120°	105	87	1800	1

* EM Discharge ≥ 3 Hours, 24 hour charge time required.

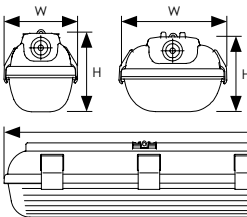

NEW

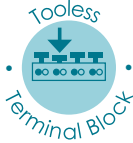

IP20 integrated fittings for use in general interior applications

- Constructed from robust IK04 impact rated steel body with Polycarbonate diffuser
- 3000K/4000K/5700K Tri-Colour Select
- 50,000 hour long life
- 100,000 switching cycles
- Toolless terminal block design
- Flip down end-caps for easy entry to fitting internals/CCT switch
- 120° beam angle
- IP20 rated for indoor use
- Colour rendering index ≥ 80
- Ambient operating temp. -20°C to 40°C (0°C to 40°C for Emergency versions)
- Available with 3 hour emergency function*

18

Product Code	Product Description	Watts (W)	Volts (V)	Colour Temp (K)	Total Lumens (lm)	Beam Angle	Dimensions (mm)			Order Qty
							W	H	L	
Standard - Single Carton										
14350	4ft Batten	20	240	3000K/4000K/5700K	2000	120°	85	75	1200	1
14374	5ft Batten	30	240	3000K/4000K/5700K	3000	120°	85	75	1500	1
14398	6ft Batten	40	240	3000K/4000K/5700K	4000	120°	85	75	1800	1
Emergency - Single Carton										
14367	4ft Batten with 3-Hour Emergency	20	240	3000K/4000K/5700K	2000	120°	85	75	1200	1
14381	5ft Batten with 3-Hour Emergency	30	240	3000K/4000K/5700K	3000	120°	85	75	1500	1
14404	6ft Batten with 3-Hour Emergency	40	240	3000K/4000K/5700K	4000	120°	85	75	1800	1
High Output - Single Carton										
14411	High Output (HO) 4ft Batten	40	240	3000K/4000K/5700K	4000	120°	85	75	1200	1
14435	High Output (HO) 5ft Batten	60	240	3000K/4000K/5700K	6000	120°	85	75	1500	1
14459	High Output (HO) 6ft Batten	80	240	3000K/4000K/5700K	8000	120°	85	75	1800	1
Emergency High Output - Single Carton										
14428	HO 4ft Batten with 3-Hour Emergency	40	240	3000K/4000K/5700K	4000	120°	85	75	1200	1
14442	HO 5ft Batten with 3-Hour Emergency	60	240	3000K/4000K/5700K	6000	120°	85	75	1500	1
14466	HO 6ft Batten with 3-Hour Emergency	80	240	3000K/4000K/5700K	8000	120°	85	75	1800	1

* EM Discharge ≥ 3 Hours, 24 hour charge time required.

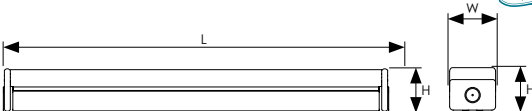

Flicker free linear batten with a sleek and slim design. Fitted with CCT technology to change the colour temperature of the LED between warm white, cool white or daylight. Available in 4ft/5ft lengths as either standard, with built-in microwave sensor or with integrated 3-hour emergency module.

- 35,000 hours long life maintenance free operation
- Constructed from an aluminium body with a polycarbonate diffuser
- Tri-colour selection switch 3000K/4000K and 6000K
- High efficiency 120lm/W
- Standard 4ft or 5ft lengths
- Colour rendering index Ra≥80
- Not suitable for dimming



Product Code	Product Description	Watts (W)	Volts (V)	Colour Temp (K)	Total Lumens (lm)	Beam Angle	Dimensions (mm)			Order Qty
							W	H	L	
Standard - Single Carton										
12219	4ft Standard	40	240	3000/4000/6000	4800	120°	80	36	1190	1
12240	5ft Standard	60	240	3000/4000/6000	7200	120°	80	36	1490	1
Microwave Sensor* - Single Carton										
12226	4ft with Microwave Sensor	40	240	3000/4000/6000	4800	120°	80	36	1190	1
12257	5ft with Microwave Sensor	60	240	3000/4000/6000	7200	120°	80	36	1490	1
3-Hour Emergency** - Single Carton										
12233	4ft with Emergency Sensor	40	240	3000/4000/6000	4800	120°	80	36	1190	1
12264	5ft with Emergency Sensor	60	240	3000/4000/6000	7200	120°	80	36	1490	1

* 6m Detection range, 5s-10min Hold time 5-∞lum light sensor Instant off or 20% light output after hold time when sensor not triggered, 30s-∞ dimming level hold

** Emergency Discharge ≥ 3 Hours, 24 hour charge time required. Built in Emergency test function. Fitted with a 4 Way Terminal block for Permanent Live

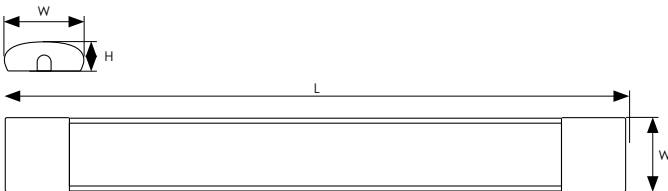

NEW



20

Energy efficient integrated LED slim-line floodlights with or without PIR sensor.

- Long life 35,000 hours maintenance free operation, 15,000 switching cycles
- Fully IP65 rated, including the PIR sensor - suitable for use outdoors
- -20°C to 40°C operating temperature
- Die-cast aluminium with black powder coat finish, stylish thin body design
- Angled mounting bracket for ease of installation without the need to disassemble the fitting
- Includes 80cm VDE cable

PIR Sensor Models

- Controls for sensitivity, time and lux levels
- 120° monitoring angle
- Override option for PIR models*
- Max detection range selectable up to 8m
- Light hold after detection selectable from 10 seconds to 7 minutes

Product Code	Watts (W)	Volts (V)	Colour Appearance	Colour Temp (K)	Useful Lumens (lm)	Total Lumens (lm)	Beam Angle	Halogen Equiv. (W)	Dimensions (mm)			Order Qty	
									W	H	D		
Single Carton													
12554	10	240	Cool White	4000	660	750	110°	60	127	102	26	1	
12561	20	240	Cool White	4000	1350	1500	110°	100	159	121	28	1	
12578	30	240	Cool White	4000	2090	2200	110°	150	197	145	29	1	
12585	50	240	Cool White	4000	3290	4000	110°	200	243	178	32	1	
With PIR - Single Carton													
12592	10	240	Cool White	4000	660	750	110°	60	127	149	55	1	
12608	20	240	Cool White	4000	1350	1500	110°	100	159	169	55	1	
12615	30	240	Cool White	4000	2090	2200	110°	150	197	191	55	1	
12622	50	240	Cool White	4000	3290	4000	110°	200	243	224	55	1	

*Includes override function - turn on/off/on to override PIR

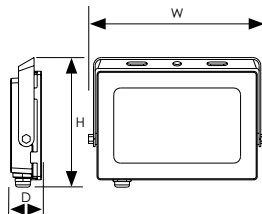
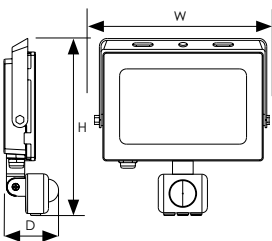

Mains operated IP65 Commercial LED Floodlights, ideal for illuminating large areas such as company car parks, industrial grounds or up-lighting buildings.

- 30,000 hours average rated life
- 15,000 switching cycles
- Die-cast aluminium with tempered glass lens IK04 Rating
- Black powder coating
- IP65 rated - suitable for outdoor use
- Fully adjustable bracket
- 110° beam angle
- Fitted with 1m TRS cable
- Instant full light



21

Product Code	Watts (W)	Volts (V)	Colour Temp (K)	Useful Lumens (lm)	Total Lumens (lm)	Beam Angle	Dimensions (mm)			Order Qty
							W	H	D	
Single Carton										
12103	100	240	4000	8300	9000	110°	255	280	90	1
12110	150	240	4000	11500	13000	110°	290	365	90	1
12127	200	240	4000	16200	18000	110°	350	435	100	1

Terminal block not included. Installation may require advice from a qualified person

Photocell version coming soon, call the sales office for more details

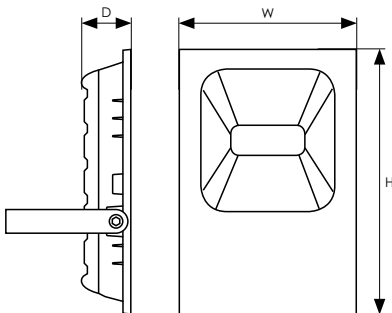



IP65 high powered energy efficient integrated LED Highbay light.

- High efficiency
- Tough and lightweight aluminium construction with IK10 impact rating and black finish
- Driver housing away from main body to maximise ventilation and prevent heat build-up to prolong life
- Glass free construction - suitable for farming, agriculture and food preparation areas
- Available in 90° and 60° beam angles
- 50,000 hour life
- 4000K cool white colour temperature
- Colour rendering index Ra≥80
- Instant full light
- Not suitable for dimming

Product Code	Watts (W)	Volts (V)	Colour Appearance	Colour Temp (K)	Useful Lumens (lm)	Total Lumens (lm)	Beam Angle	Dimensions (mm)		Order Qty
								Dia	H	
Single Carton										
12431	100	220-240	Cool White	4000	9800	13000	90°	275	166	1
12448	150	220-240	Cool White	4000	14500	18000	90°	285	166	1
12455	200	220-240	Cool White	4000	19100	24000	90°	305	183	1
12462	100	220-240	Cool White	4000	9800	13000	60°	275	166	1
12479	150	220-240	Cool White	4000	14500	18000	60°	285	166	1
12486	200	220-240	Cool White	4000	19100	24000	60°	305	183	1

Microwave Sensor version coming soon, call the sales office for more details

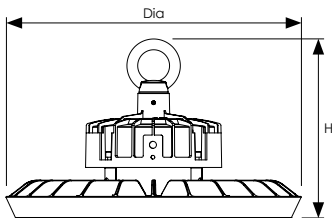

PHOEBE
LED

23



KRIOS

Here at **PHOEBE LED** as we continue to develop our portfolio of LED fixtures to cover a range of projects such as Leisure, Commercial, Industrial and Domestic, we are pleased to announce the launch of our new '**KRIOS**' range of Emergency Luminaires.

With extensive research and market feedback we have identified the key lines in this sector, and are pleased to offer a high quality and well-priced range of fixtures that will allow our customers to complete their lighting project to the highest standard and comply with the design brief.

All Krios products are backed by our 3 year product and 1 year on-site warranty.



Simply cost effective, efficient, lighting products every time.

**PHOEBE
LED**

KRIOS
EMERGENCY
BULKHEAD



LED emergency bulkhead with up, down, left, right direction legends pack. Constructed from tough polycarbonate.

- Suitable for surface mounting
- Maintained or non-maintained functions
- 3 years life span with 500 recharge cycles
- 3-hour emergency running time
- 24-hour charge time
- IP65 rated for indoor or outdoor use
- Features an integrated emergency driver fitted with a 3.6V 1.0Ah Ni-cd battery

24

Product Code	Watts (W)	Volts (V)	Dimensions (mm)			Order Qty
			W	D	H	
Single Carton						
13971	4	240	352	67	110	1

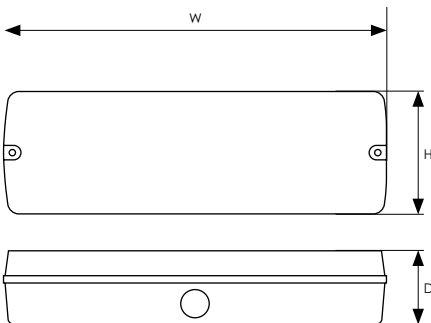



KRIOS

EMERGENCY
TWIN SPOT

PHOEBE
LED

LED emergency twin spot light with independently angled spotlight heads.

- Non-maintained functionality
- 3 years life span with 500 recharge cycles
- 3-hour emergency running time
- 24-hour charge time
- IP65 rated for indoor or outdoor use
- Features an integrated emergency driver fitted with a 12V 1.5Ah Ni-cd battery



25

Product Code	Watts (W)	Volts (V)	Total Lumens (lm)	Dimensions (mm)			Order Qty
				W	D	H	
Single Carton							
13995	2.3	240	400	300	82	294	1

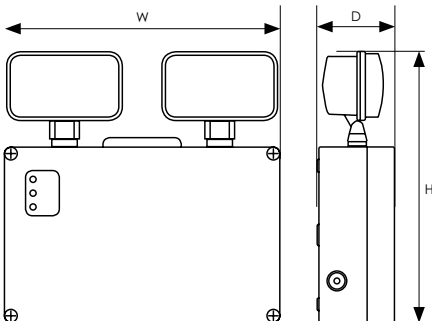

**PHOEBE
LED**

**KRIOS
EMERGENCY
SPOT**

26



LED emergency spotlight for recessed installation. Fitted with remote emergency driver. Available with round or additional corridor lens.

- Suitable for recessed installation
- Non-maintained functionality
- Manual test function with LED indicator
- Long life maintenance free operation with 50,000 hours
- 3 years life span with 500 recharge cycles
- 3-hour emergency running time
- 24-hour charge time
- IP20 rated for indoor use
- Emergency driver fitted with a LiFePO4 3.2V 1500mAh battery
- Round lens design for use in open areas complete with emergency driver
- Additional corridor lens for narrow areas and walkways (to be used with product code 14008)

Product Code	Details	Watts (W)	Volts (V)	Dimensions (mm)			Order Qty
				Dia	H	Cutout	
Single Carton							
14008	Round Lens with Emergency Driver	1	240	95	30	70	1
14015	Corridor Lens (no driver)	1	240	95	30	70	1

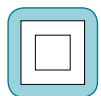
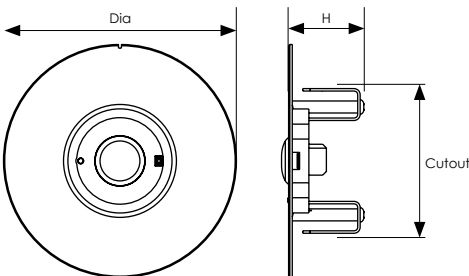

A sleek and stylish LED emergency blade with down arrow legend set and integrated emergency driver. Can be surface mounted to either ceilings and walls, or can be mounted perpendicular to a wall. Optional suspension kit or recessed kit available.

- Suitable for surface mounting on ceilings or walls
- Maintained or non-maintained functionality
- Manual test function with LED indicator
- 3 years life span with 500 recharge cycles
- 3-hour emergency running time
- 24-hour charge time
- IP20 rated for indoor use
- Features an integrated emergency driver fitted with a LiFePO4 3.2V 600mAh battery
- Base unit comes complete with arrow down legend set
- Up, left and right legend sets available
- Legend sets compliant with ISO3864 - Parts 1&3 with 26m legible viewing distance
- Optional suspension kit or recessed kit available



Product Code	Details	Watts (W)	Volts (V)	Dimensions (mm)			Order Qty
				W	H	D	
Single Carton							
14022	LED Emergency Blade with Down Arrow Legend	2	240	267	187	34	1
14039	Legend Set - Arrow Up			261	133		1
14046	Legend Set - Arrow Left/Right			261	133		1
14565	Suspension Kit						
14572	Recessed Kit						

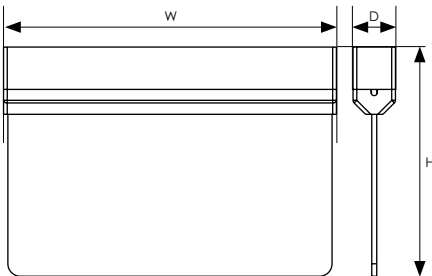



LED emergency wall box with down arrow legend set and integrated emergency driver. Constructed from steel with acrylic front panel.

- Suitable for surface mounting
- Maintained or non-maintained functionality
- 3 years life span with 500 recharge cycles
- 3-hour emergency running time
- 24-hour charge time
- IP20 rated for indoor use
- Features an integrated emergency driver fitted with a 3.6V 1.8Ah Ni-cd battery

28



Product Code	Details	Watts (W)	Volts (V)	Dimensions (mm)			Order Qty
				W	D	H	
Single Carton							
14060	LED Emergency Wall Box	1.8	240	316	75	228	1
14077	Legend Set - Arrow Up						1
14084	Legend Set - Arrow Left						1
14091	Legend Set - Arrow Right						1

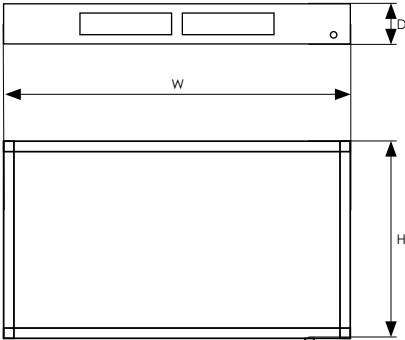



LED TERRA GARDEN SPIKE

PHOEBE LED

LED mains powered LED floodlight, supplied with 17cm garden spike, can also be surface mounted.

- 25,000 hour life
- 12,500 switching cycles
- IP65 rated for outdoor use
- Suitable for electronic switching, electronic timers and PIR sensors
- Constructed from tough IK07 rated ASA plastic, with diecast aluminium spike
- Suitable for gardens to illuminate features such as statues, shrubs, trees and flowers or to illuminate walls and fences/trellises etc.
- 1 metre VDE cable attached
- Instant full light
- Not suitable for dimming



29

Product Code	Watts (W)	Volts (V)	Colour Appearance	Colour Temp (K)	Useful Lumens (lm)	Total Lumens (lm)	Beam Angle	Halogen Equiv. (W)	Dimensions (mm)				Order Qty
									H1	W	D	H2	
Single Carton													
6188	10	240	Cool White	4000	820	1000	60°	70	134	135	43	174	1

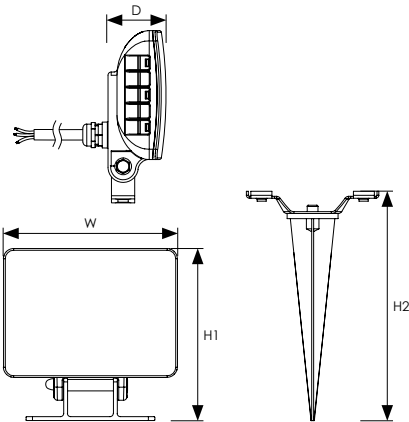

**PHOEBE
LED**

LED MINI LINK-LIGHT

Be your own lighting designer with these high quality customizable under-cabinet LED lights. Featuring an ultra-slim design in a variety of lengths. Connectors, leads, switches and drivers are also available.

- 40,000 hour life long life
- 20,000 switching cycles
- Phoebe LED driver required
- Dimmable - using optional dimmer switch (product code:5020)
- IP20 rated suitable for indoor use only

30



Product Code	Product Description	Watts (W)	Volts (V)	Colour Appearance	Colour Temp (K)	Total Lumens (lm)	Beam Angle	Dimensions (mm)			Order Qty
								W	H	L	
LED Mini Link-Light - Single Carton											
4894	LED Mini Link-Light 15cm	2.5	24	Warm White	3000	195	100	18	8	150	1
4900	LED Mini Link-Light 30cm	5	24	Warm White	3000	325	100	18	8	300	1
4917	LED Mini Link-Light 60cm	9	24	Warm White	3000	590	100	18	8	600	1
4931	LED Mini Link-Light 15cm	2.5	24	Cool White	4000	195	100	18	8	150	1
4948	LED Mini Link-Light 30cm	5	24	Cool White	4000	325	100	18	8	300	1
4955	LED Mini Link-Light 60cm	9	24	Cool White	4000	590	100	18	8	600	1
4962	LED Mini Link-Light 100cm	15	24	Cool White	4000	975	100	18	8	1000	1
Power Supply - Single Carton											
4979	20W Driver & On/Off Switch	20	240					40	22	125	1
4993	60W Driver & On/Off Switch	60	240					52.5	30	115	1
5006	120W Driver & On/Off Switch	120	240					65.5	35	162	1
Switches - Single Packet											
5013	Additional Touch Sensitive On/Off Switch							18	8	67	1
5020	Touch Sensitive Dimmer Switch							18	8	67	1
5037	Motion Sensor On/Off Switch							18	8	67	1

Mini Link-Light includes: 1x Mini Link-Light Length, 1x Clear Connector, 1x Clear End Cap and 2x Mounting Brackets.

Mini Link-Light Power Supply includes: 1x Power Supply, 1x Touch Sensitive On/Off Switch, Power Leads, 3M Adhesive Pads.

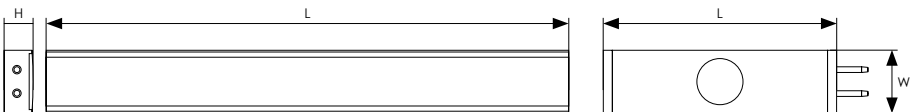



Product Code	Product Description	Dimensions (mm)			Order Qty
		W	H	L	
Link-Leads - Single Packet					
5068	4-Way Adapter Lead			500	1
5051	Link-Lead (Male to Male) - Flexibly Connects Link-Light to Link-Light			500	1
5648	Link Lead (Male to female) - Flexibly Connects Switch to Link-Light			500	1
Connectors - Single Packet					
5075	2-Way Connector Left	20	12	20	1
5082	2-Way Connector Right	20	12	20	1
5099	3-Way Connector T-Shaped	20	12	20	1
5105	4-Way Connector	20	12	20	1
5112	Internal Corner Connector	20	12	12	1
Mounting Brackets - Single Packet					
5136	45° Angled Mounting Brackets (Pack of 4)				1
Point-of-Sale Marketing					
4891	LED Mini Link-Light Foam Slat-Wall Header Card	800	300		1
4892	LED Mini Link-Light Interactive Display Board	400	300		1
4893	LED Mini Link-Light Pack of 50 Flyers	99	210		1

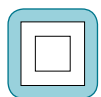

**PHOEBE
LED**

LED FLEXI STRIP-LIGHT



32

Flexible LED strip-light, with a self-adhesive 3M backing, can be attached to almost any surface. Suitable for indoor or outdoor applications. LED strip light can be cut at regular intervals for custom DIY applications.

- 30,000 hour life
- RGB, warm white or cool white colour options
- RGB driver kit includes infrared remote control and receiver with dimming, strobe and flash functions
- Class II
- IP65 rated

Product Code	Product Description	Watts (W)	Volts (V)	Colour Appearance	Colour Temp (K)	Total Lumens (lm)	Dimensions (mm)			Order Qty
							W	H	L	
RGB LED Flexi Strip-Light 5 Metre Kit - Blister Pack										
12516	5M LED Flexi Strip-Light Kit RGB Contents: 1x IP65 5M LED Flexi Strip-Light RGB, 1x IP20 AC power adapter with integrated UK plug, 1x infrared remote control, 1x infrared receiver, 2x 10cm flexible connectors with clamp to both ends and 2x straight connectors with clamp to both ends	32	24	RGB			10	3	5000	1
12530	RGB Driver Kit Larger driver to support combined LED strips up to 10m in length	60	24							1
Warm White Flexi Strip-Light 5 Metre Kit - Blister Pack										
12493	5M LED Flexi Strip-Light Kit WW Contents: 1x IP65 5M LED Flexi Strip-Light WW, 1x IP20 AC power adapter with integrated UK plug, 2x 10cm flexible connectors with clamp to both ends and 2x straight connectors with clamp to both ends	20	24	Warm White	2700	1800	8	3	5000	1
12523	WW/CW Driver Kit Larger driver to support combined LED strips up to 10m in length	48	24							1
Cool White LED Flexi Strip-Light 5 Metre Kit - Blister Pack										
12509	5M LED Flexi Strip-Light Kit CW Contents: 1x IP65 5M LED Flexi Strip-Light CW, 1x IP20 AC power adapter with integrated UK plug, 2x 10cm flexible connectors with clamp to both ends and 2x straight connectors with clamp to both ends	20	24	Cool White	4000	1900	8	3	5000	1
12523	WW/CW Driver Kit Larger driver to support combined LED strips up to 10m in length	48	24							1

Accessories

12547	Accessory Kit for LED Flexi Strip-Light Kits For re-connecting cut-off lengths of 5M LED Flexi Strip-Light Contents: 2x 15cm flexible connector with clamp to both ends (RGB), 2x 2x straight connectors with clamp to both ends (RGB) and 2x 15cm flexible connector with clamp to both ends (CW/WW), 2x 2x straight connectors with clamp to both ends (CW/WW)									1
-------	---	--	--	--	--	--	--	--	--	---

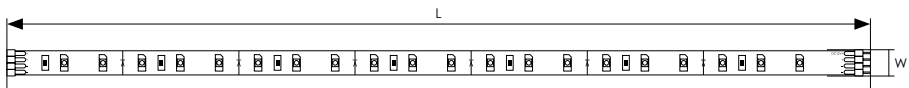

Mains operated energy efficient integrated LED Recessed Scoop Light, dual use for downlight/spotlight.

- 30,000 hours long life maintenance free operation
- 100,000 switching cycles
- 355° rotation and 0° to 40° tilt angle
- Includes LED driver
- Polycarbonate lens and diecast aluminium in a white finish
- IP20 rated suitable for indoor use only
- Not suitable for dimming
- Instant full light



Product Code	Product Description	Watts (W)	Volts (V)	Colour Appearance	Colour Temp (K)	Useful Lumens (lm)	Total Lumens (lm)	Beam Angle	Dimensions (mm)			Order Qty
									Dia	H	Cutout ø	
Single Carton												
10406	Recessed Scoop	37	240	Warm White	3000	3750	4000	25°	190	137	175	1
10413	Recessed Scoop	37	240	Cool White	4000	3800	4050	25°	190	137	175	1

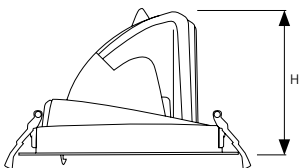
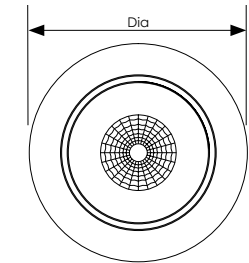

Universal mains voltage 3-circuit track system.

- Available in a multitude of lengths, corners and couplers to suit any installation
- Features a ridge so that any fitted corner or coupler maintains the polarity and correct circuit selection of the track installation. The ridge can be used on the inside edge or the outside edge
- Suitable for use with Phoebe LED Alecto Dimmable track light and Phoebe LED Ares track light

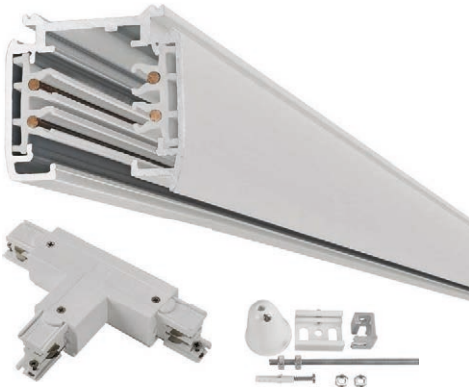

Sample Circuits

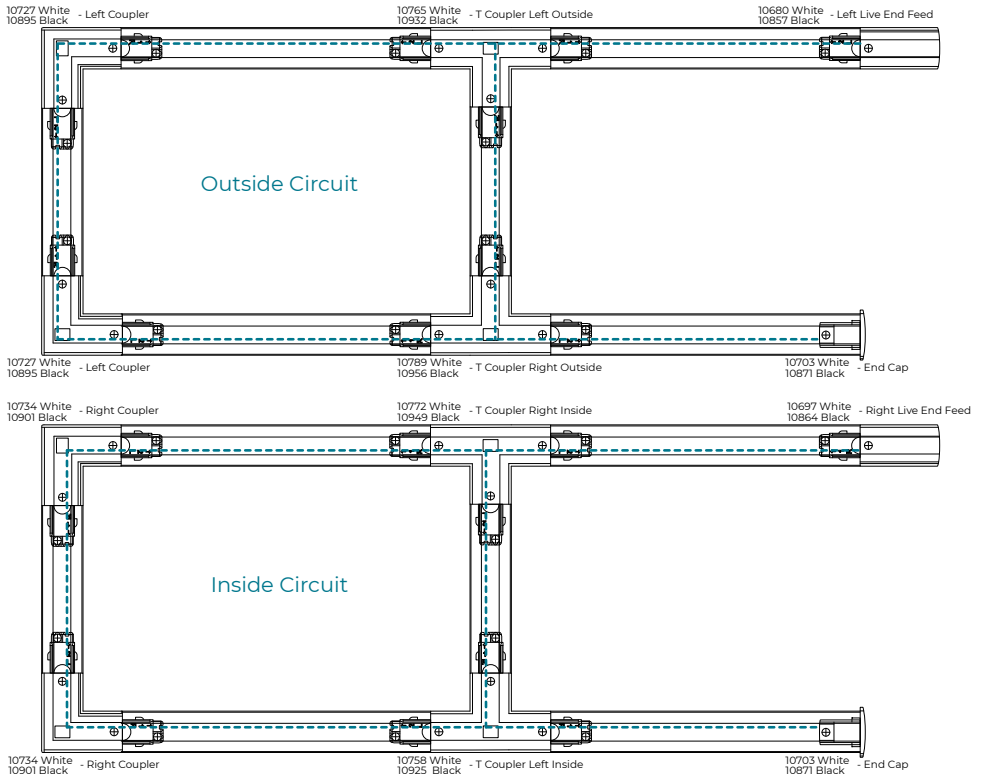



Product Code	Finish	Description	Diagram	Dimensions (mm)			Order Qty
				L	H	W	
10826	Black	1m 3-Circuit Track (2 mounting points)		1000	35.5	35.2	1
10666	White	2m 3-Circuit Track (3 mounting points)		2000	35.5	35.2	1
10833	Black						
10840	Black	3m 3-Circuit Track (4 mounting points)		3000	35.5	35.2	1
10680	White	Left Live End Feed		98	35.5	35.2	1
10857	Black						
10697	White	Right Live End Feed		98	35.5	35.2	1
10864	Black						
10703	White	End Cap		31	35.5	35.2	1
10871	Black						
10888	Black	Coupler		165	35.5	35.2	1
10727	White	Left Coupler		101	35.5	101	1
10895	Black						
10734	White	Right Coupler		101	35.5	101	1
10901	Black						

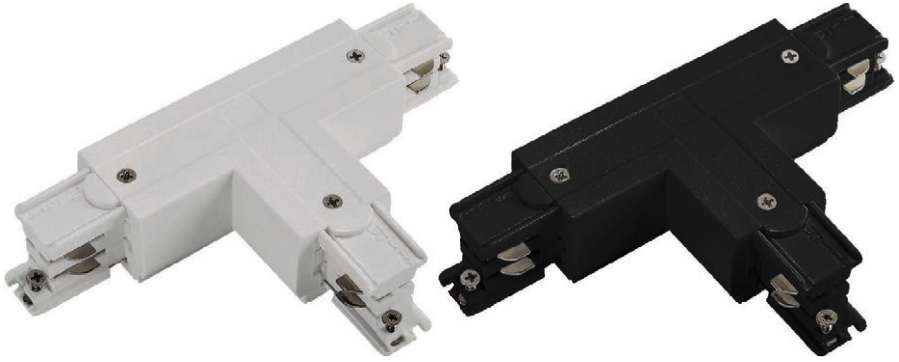

Product Code	Finish	Description	Diagram	Dimensions (mm)			Order Qty
				L	H	W	
10758	White	T-Coupler Left Inside		101	35.5	166	1
10925	Black						
10765	White	T-Coupler Left Outside		101	35.5	166	1
10932	Black						
10772	White	T-Coupler Right Inside		101	35.5	166	1
10949	Black						
10789	White	T-Coupler Right Outside		101	35.5	166	1
10956	Black						

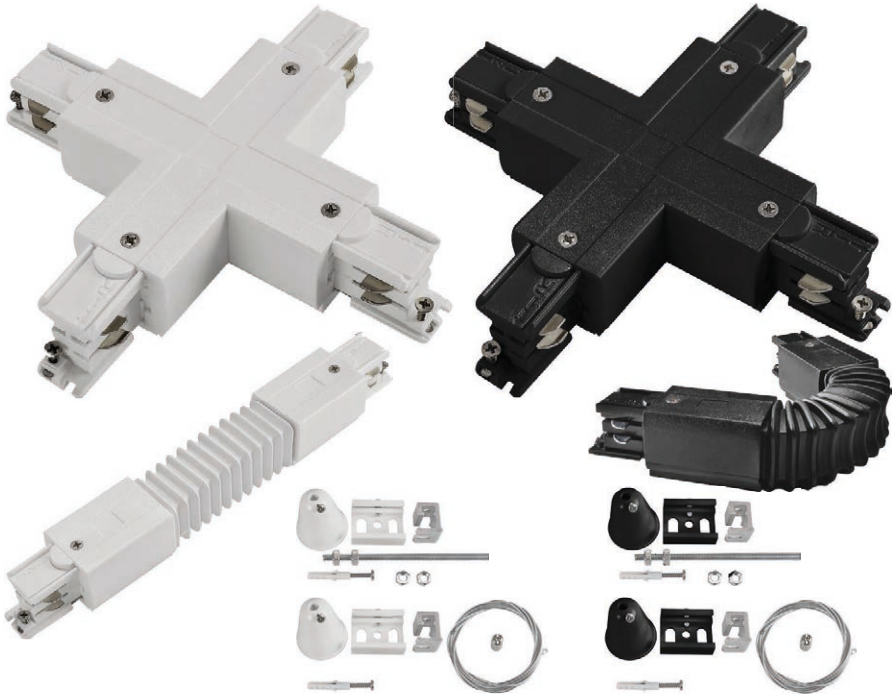

Product Code	Finish	Description	Diagram	Dimensions (mm)			Order Qty
				L	H	W	
10741	White	X-Coupler		166	35.5	166	1
10918	Black						
10796	White	Flexible Coupler		248	35.5	35.2	1
10963	Black						
10802	White	Rigid Suspension Kit (1 per mounting point)		-	-	-	1
10970	Black						
10819	White	Wire Suspension Kit (1 per mounting point)		-	-	-	1
10987	Black						

Note: Check the ridge/groove position on the diagram to ensure correct polarity and circuit selection is maintained.

**PHOEBE
LED**

LED ALECTO

Energy efficient dimmable LED Track Spot-Light.



38



- 40,000 hours long life
- Universal adapter for 3-circuit track systems
- Circuit selection dial
- Built in dimmer control on luminaire base, total output adjustable from 20% - 100%
- 360° Horizontal and 180° vertical spot-light adjustment
- 24° narrow beam angle
- Constructed from tough polycarbonate and aluminium
- IP20 rating suitable for indoor use
- Instant full light

Product Code	Watts (W)	Volts (V)	Colour Appearance	Colour Temp (K)	Useful Lumens (lm)	Total Lumens (lm)	Beam Angle	Dimensions (mm)					Order Qty
								Dia	W	D1	D2	D3	
Black Finish - Single Carton													
9585	25	240	Cool White	4000	1940	2050	24°	90	146	212	174	162	1
White Finish - Single Carton													
9592	25	240	Cool White	4000	1940	2050	24°	90	146	212	174	162	1

Phoebe 3-Circuit track system now available - see pages 34-37

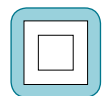
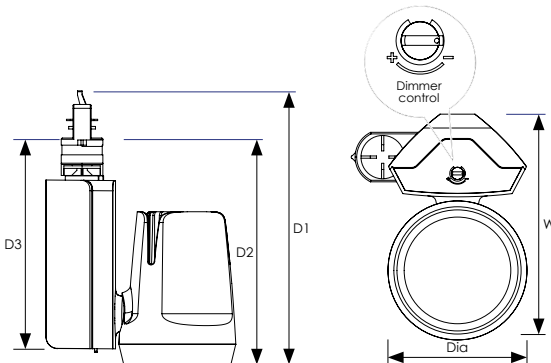

Energy efficient LED track spot-light.

- 40,000 hours long life maintenance free operation
- Universal adapter for all 3-circuit track systems
- Circuit selection knob
- Constructed from tough polycarbonate and aluminium
- 360° horizontal and 180° vertical spot-light adjustment
- Faceted reflector to provide precise beam control
- Available in white or black finish
- Instant full light
- IP20 rated for indoor use only
- Not suitable for dimming



Product Code	Watts (W)	Volts (V)	Colour Appearance	Colour Temp (K)	Useful Lumens (lm)	Total Lumens (lm)	Beam Angle	Dimensions (mm)					Order Qty
								Dia	W	D1	D2	D3	
Black Finish - Single Carton													
6713	35	240	Warm White	3000	2650	3000	24°	110	110	234	167	131	1
6720	35	240	Cool White	4000	2870	3300	24°	110	110	234	167	131	1
White Finish - Single Carton													
6737	35	240	Warm White	3000	2650	3000	24°	110	110	234	167	131	1
6744	35	240	Cool White	4000	2870	3300	24°	110	110	234	167	131	1

Phoebe 3-Circuit track system now available - see pages 34-37

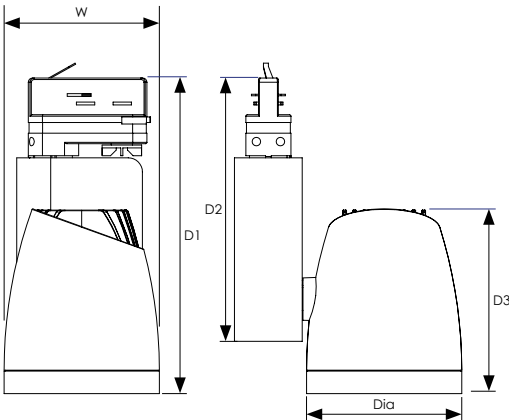

**PHOEBE
LED**

Intelligent Dimmer Switch

NEW



Imbue your standard dimmable lamps with smart connectivity with this Intelligent touch sensitive Wi-Fi dimmer control switch, Gives traditional functionality and touch sensitive dimming.

- Connects wirelessly with your home network, no bridge device required
- Home hub compatible*1
- Smart device compatible, Tuya Smart app required*2
- Supports 220W max of dimmable LED lamps, or 300W max of traditional lamps
- Not for use with smart/Wi-Fi controlled lamps
- Control dimmable lights on 1 circuit by either touch, Tuya smart app or by voice control via a home hub
- Switch requires an AC neutral In feed from the lighting circuit (see wiring diagram)

40

Product Code	Description	Dimensions (mm)				Order Qty
		W	H	D ¹	D ²	
Single Carton						
14671	Intelligent touch sensitive Wi-Fi dimmer control switch	89	86	26	8.7	1

Installation may require advice from a qualified person.

*1 works with most home hubs, requires Tuya protocol see website for details.

*2 Android or Apple smart device required for setup using the Tuya app.

WiFi 2.4 GHz 802.11b/g/n

**Fits in a standard
35mm back box**

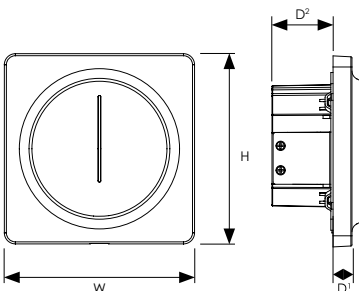
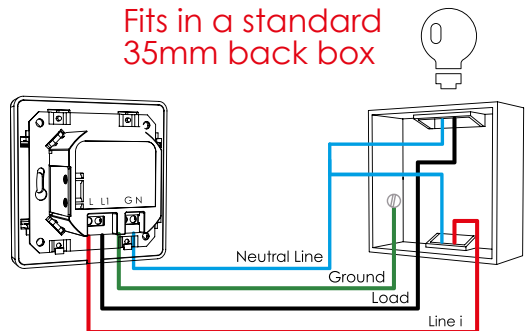



Voice control:
Google Home
Amazon Echo



Tuya Smart



Download on the
App Store



GET IT ON
Google Play



5 YEAR
WARRANTY



Touch



Smart Device



Home Hub



SMART

WIRELESS LIGHTING

Take full control and personalise your modern lighting experience with Crompton Lamps **SMART WIRELESS LIGHTING** designed to complement your lifestyle.

Create custom lighting schemes to change colour, schedule lights to switch on or off at set times and control your lights from anywhere all with the swipe of your finger or by voice command.

Crompton Lamps **SMART** range of lamps and fixtures, offer simple and affordable entry into the world of next generation lighting. With simple set up and No Hub required the Crompton Lamps **SMART** range with Tuya offers everyone the opportunity to control the lighting in their home or business as they desire.



Simply cost effective, efficient, lighting products every time.

NEW



Fire rated energy efficient integrated LED downlight with smart controlled tuneable white spotlight and dimming function.

- Connects wirelessly with your home network, no bridge device required
- Home hub compatible*1
- Smart device compatible, Tuya Smart app required*2
- 30, 60 & 90 minute fire rated - Fully compliant and certified to BS476 Parts 21 and 22
- Tuneable white 2700K Warm White to 6500K Daylight
- Dimmable*3 - Via App or home hub
- 50,000 hours long life maintenance free operation
- Features insulation guards for added ventilation and safety to prevent the Firesafe from being covered by insulation material
- Supplied with separate tool-less loop-in/loop-out constant current driver for quick and easy installation
- Includes 2x quick change bezels in White and Satin Nickel, polished chrome bezel available separately
- IP65 rated
- Constructed from die-cast aluminium
- Instant full light

Product Code	Watts (W)	Volts (V)	Colour Appearance	Colour Temp (K)	Useful Lumens (lm)	Total Lumens (lm)	Beam Angle	Dimensions (mm)			Order Qty	
								Dia	H	Cutout ø		
Single Carton												
12851	8.5	240	Warm-Cool-Daylight	2700-6500	650	700	60°	89	65	70-72	1	
12646-10			Polished Chrome Bezel - 10 Pack			-	-	-	89	5	-	1

Supplied with a tool-less loop-in/loop-out quick connector. Installation may require advice from a qualified person. Part L Compliant of UK Building Regulations. Part B Compliant BS476 Parts 21 and 22. Suitable for 30 minute 600mm/15mm single layer Standard Wallboard, 60 minute 600mm/12.5mm twin layer Fireboard and 90 minute 450mm/15mm twin layer Fireboard ceilings.

*1 works with most home hubs, requires Tuya protocol see website for details.
 *2 Android or Apple smart device required for setup using the Tuya app.
 *3 Dimmable via App or home hub, not compatible with a physical dimmer switch.

WiFi 2.4 GHz 802.11 b/g/n

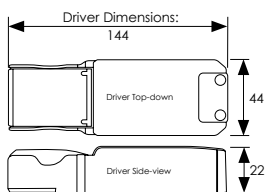
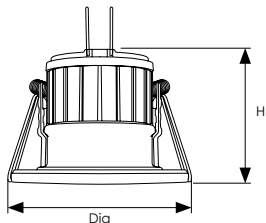

Voice control: **Google Home** **Amazon Echo**

Tuya Smart

Download on the **App Store**

GET IT ON **Google Play**

- Fire Rated 30, 60, 90 mins
- IP65 Rating
- Home Hub
- Smart Dimmable
- 5 YEAR WARRANTY
- Suitable for Bathroom use Zones 1-2
- Tuneable White
- Smart Device

Energy saving LED SMART GLS lamp. Lightweight thermal plastic heat dissipating body and opal lens. Connects to your home network and control via your smart device or home hub.

- Connects wirelessly with your home network, no bridge device required
- Home hub compatible*¹
- Smart device compatible, Tuya Smart app required*²
- Closely resembles the look and feel of traditional GLS lamp
- Colour changing RGB with 3000K warm white or standard 3000K warm white options
- 806lm total lumens
- Dimmable*³ - Via App or home hub
- 15,000 hours average rated life
- 10,000 switching cycles
- BC-B22d or ES-E27 caps
- Opal finish
- Instant full light
- Recommended for indoor use



Product Code	Watts (W)	Volts (V)	Cap	Colour Appearance	Colour Temp (K)	Total Lumens (lm)	Incandescent Equivalent (W)	Dimensions (mm)		Energy Rating	Order Qty
								Dia	H		
Single Carton											
12301	8.5	240	BC-B22d	Warm White	3000	806	60	60	107	A+	1
12318	8.5	240	ES-E27	Warm White	3000	806	60	60	107	A+	1
12325	8.5	240	BC-B22d	RGB+ Warm White	RGB+ 3000	806	60	60	107	A+	1
12332	8.5	240	ES-E27	RGB+ Warm White	RGB+ 3000	806	60	60	107	A+	1

*¹ works with most home hubs, requires Tuya protocol see website for details.
*² Android or Apple smart device required for setup using the Tuya app.
*³ Dimmable via App or home hub, not compatible with a physical dimmer switch.
WiFi 2.4 GHz 802.11b/g/n

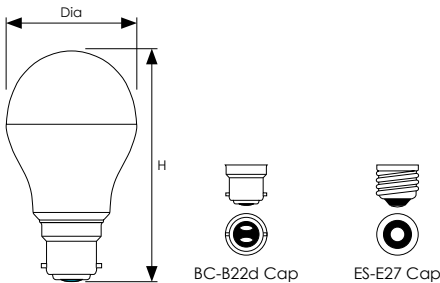



LED SMART Candle



Energy saving LED SMART candle lamp. Lightweight thermal plastic heat dissipating body and opal lens. Connects to your home network and control via your smart device or home hub.

- Connects wirelessly with your home network, no bridge device required
- Home hub compatible*1
- Smart device compatible, Tuya Smart app required*2
- Closely resembles the look and feel of traditional candle lamp
- Colour changing RGB with 3000K warm white or standard 3000K warm white options
- 470lm total lumens
- Dimmable*3 - Via App or home hub
- 15,000 hours average rated life
- 10,000 switching cycles
- BC-B22d or SES-E14 caps
- Opal finish
- Instant full light
- Recommended for indoor use

44

Product Code	Watts (W)	Volts (V)	Cap	Colour Appearance	Colour Temp (K)	Total Lumens (lm)	Incandescent Equivalent (W)	Dimensions (mm)		Energy Rating	Order Qty
								Dia	H		
Single Carton											
12349	5	240	BC-B22d	Warm White	3000	470	40	37	108	A+	1
12356	5	240	SES-E14	Warm White	3000	470	40	37	108	A+	1
12363	5	240	BC-B22d	RGB+ Warm White	RGB+ 3000	470	40	39	114	A+	1
12370	5	240	SES-E14	RGB+ Warm White	RGB+ 3000	470	40	39	114	A+	1

*1 works with most home hubs, requires Tuya protocol see website for details.

*2 Android or Apple smart device required for setup using the Tuya app.

*3 Dimmable via App or home hub, not compatible with a physical dimmer switch.

WiFi 2.4 GHz 802.11b/g/n

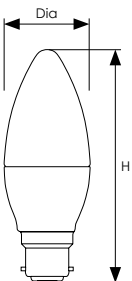

Energy saving LED SMART GU10 lamp. Lightweight thermal plastic heat dissipating body and opal lens. Connects to your home network and control via your smart device or home hub.



- Connects wirelessly with your home network, no bridge device required
- Home hub compatible*¹
- Smart device compatible, Tuya Smart app required*²
- Closely resembles the look and feel of traditional Halogen GU10 lamp
- Colour changing RGB with 3000K warm white or 4000K cool white and tuneable white 2700K-4000K options
- 320 useful lumens, 360lm total lumens
- Dimmable*³ - Via App or home hub
- 15,000 hours average rated life
- 10,000 switching cycles
- Opal finish
- Instant full light
- Recommended for indoor use



45

Product Code	Watts (W)	Volts (V)	Cap	Colour Appearance	Colour Temp (K)	Useful Lumens (lm)	Total Lumens (lm)	Beam Angle	Halogen Equivalent (W)	Dimensions (mm)		Energy Rating	Order Qty
										Dia	H		
Single Carton													
12387	5	240	GU10	Tuneable white	2700-4000	320	360	100°	50	50	58	A+	1
12394	5	240	GU10	RGB+ Warm White	RGB+ 3000	320	360	100°	50	50	58	A+	1
12400	5	240	GU10	RGB+ Cool White	RGB+ 4000	320	360	100°	50	50	58	A+	1

*¹ works with most home hubs, requires Tuya protocol see website for details.

*² Android or Apple smart device required for setup using the Tuya app.

*³ Dimmable via App or home hub, not compatible with a physical dimmer switch.

WiFi 2.4 GHz 802.11b/g/n

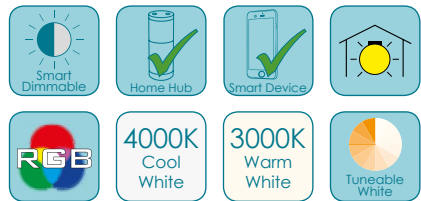
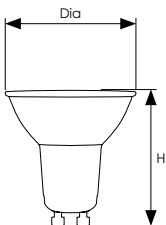



LED SMART 5m Flexi-Strip Kit



NEW



46

Kit contains:

- 1x 5 meter flexi-strip
- 2x 15cm connecting leads,
- 1x power supply with integrated LED and UK plug
- 1x WiFi controller box



Energy saving LED SMART 5m Flexi-Strip. Connects to your home network and control via your smart device or home hub.

- Connects wirelessly with your home network, no bridge device required
- Home hub compatible*1
- Smart device compatible, Tuya Smart app required*2
- Colour changing RGB with tuneable white 2700K-6500K
- 1500lm total lumens
- Dimmable*3 - Via App or home hub
- Strong 3M backing for easy and sturdy installation
- Cut and re-join at 10cm intervals
- 2x connecting leads supplied
- 20,000 hours average rated life
- 10,000 switching cycles
- Instant full light
- Recommended for indoor use

Product Code	Watts (W)	Volts (V)	Colour Appearance	Colour Temp (K)	Total Lumens (lm)	Dimensions (mm)			Energy Rating	Order Qty
						L	W	H		
Single Carton										
12417	18	240	RGB+ Tuneable White	RGB+ 2700-6500	1500	5000	12	3	A+	1

*1 works with most home hubs, requires Tuya protocol see website for details.
 *2 Android or Apple smart device required for setup using the Tuya app.
 *3 Dimmable via App or home hub, not compatible with a physical dimmer switch.
 WiFi 2.4 GHz 802.11b/g/n

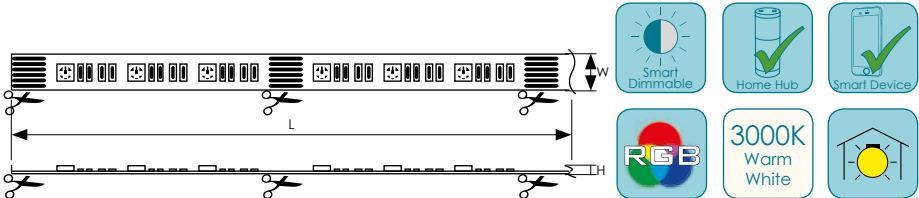



LED Filament GLS Clear Dimmable



Energy saving LED replacement lamp featuring LED filament technology to closely resemble the look and feel of a traditional incandescent lamp.

- 10,000 hour life
- 5,000 switching cycles
- 2700K warm white
- Colour rendering index Ra≥80
- Dimmable - DuoDim™ Technology compatible with both leading and trailing edge dimmers*
- Recommended for indoor use only
- Available in 5W or 7.5W
- BC-B22d or ES-E27 cap
- Clear finish



Product Code	Watts (W)	Volts (V)	Cap	Colour Appearance	Colour Temp (K)	Total Lumens (lm)	Incandescent Equivalent (W)	Dimensions (mm)		Energy Rating	Order Qty
								Dia	H		
Clear Filament - Single Carton											
4184	5	240	BC-B22d	Warm White	2700	470	40	60	102	A+	10
4191	5	240	ES-E27	Warm White	2700	470	40	60	104	A+	10
4207	7.5	240	BC-B22d	Warm White	2700	806	60	60	102	A+	10
4214	7.5	240	ES-E27	Warm White	2700	806	60	60	104	A+	10

* The lamp is compatible with most dimmer switches, please refer to website for up-to-date list of compatible dimmer switches.

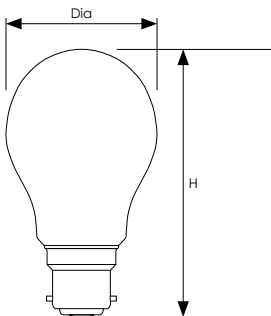

BC-B22d Cap



ES-E27 Cap



View on Youtube





LED Filament Candle/Round Clear Dimmable & Non-Dimmable

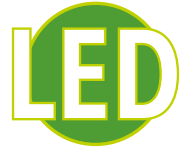

Energy saving LED replacement lamp featuring LED filament technology to closely resemble the look and feel of a traditional incandescent lamp.



- 10,000 hour life
- 5,000 switching cycles
- 2700K warm white
- Colour rendering index Ra≥80
- BC-B22d, ES-E27, SBC-B15d cap and SES-E14 cap
- Clear finish
- Dimmable or non-dimmable options
- Dimmable option utilizes DuoDim™ Technology compatible with both leading and trailing edge dimmers*
- Recommended for indoor use only

48

Product Code	Watts (W)	Volts (V)	Cap	Colour Appearance	Colour Temp (K)	Total Lumens (lm)	Incandescent Equivalent (W)	Dimensions (mm)		Energy Rating	Order Qty
								Dia	H		
Dimmable Candle - Single Carton											
7130	5	240	BC-B22d	Warm White	2700	470	40	35	91	A+	10
7147	5	240	SBC-B15d	Warm White	2700	470	40	35	95	A+	10
7154	5	240	ES-E27	Warm White	2700	470	40	35	93	A+	10
7161	5	240	SES-E14	Warm White	2700	470	40	35	97	A+	10
Non-Dimmable Round - Single Carton											
4467	4	240	ES-E27	Warm White	2700	470	40	45	78	A+	10
Dimmable Round - Single Carton											
7215	5	240	BC-B22d	Warm White	2700	470	40	45	76	A+	10
7222	5	240	SBC-B15d	Warm White	2700	470	40	45	78	A+	10
7239	5	240	ES-E27	Warm White	2700	470	40	45	78	A+	10
7246	5	240	SES-E14	Warm White	2700	470	40	45	80	A+	10

* The lamp is compatible with most dimmer switches, please refer to website for up-to-date list of compatible dimmer switches.

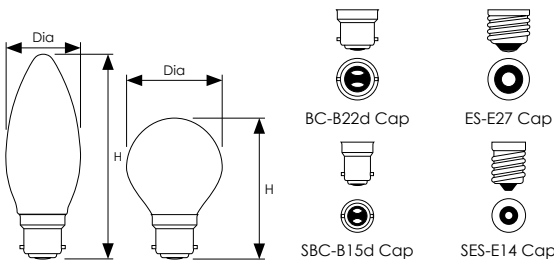



LED Filament Bent-tip Candle Dimmable



Energy saving LED replacement lamp featuring LED filament technology to closely resemble the look and feel of a traditional incandescent lamp.

- 10,000 hour life
- 5,000 switching cycles
- 2 year warranty
- 2700K warm white
- Colour rendering index Ra≥80
- BC-B22d, ES-E27 cap SBC-B15d and SES-E14 cap
- Clear finish
- Dimmable, utilizes DuoDim™ Technology compatible with both leading and trailing edge dimmers*
- Recommended for indoor use only



Product Code	Watts (W)	Volts (V)	Cap	Colour Appearance	Colour Temp (K)	Total Lumens (lm)	Incandescent Equivalent (W)	Dimensions (mm)		Energy Rating	Order Qty
								Dia	H		
Dimmable Candle - Single Carton											
12134	5	240	BC-B22d	Warm White	2700	470	40	35	114	A+	1
12141	5	240	SBC-B15d	Warm White	2700	470	40	35	121	A+	1
12158	5	240	ES-E27	Warm White	2700	470	40	35	116	A+	1
12165	5	240	SES-E14	Warm White	2700	470	40	35	123	A+	1

* The lamp is compatible with most dimmer switches, please refer to website for up-to-date list of compatible dimmer switches.

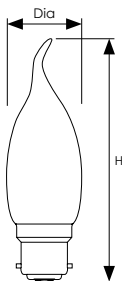

BC-B22d Cap



SBC-B15d Cap



ES-E27 Cap

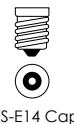

SES-E14 Cap





LED Filament GLS Pearl Dimmable



Energy saving LED replacement lamp featuring LED filament technology to closely resemble the look and feel of a traditional pearl incandescent lamp.

- 10,000 hour life
- 5,000 switching cycles
- 2700K warm white
- Colour rendering index Ra≥80
- Dimmable - DuoDim™ Technology compatible with both leading and trailing edge dimmers*
- Recommended for indoor use only
- Available in 5W or 7.5W
- BC-B22d or ES-E27 cap
- Pearl finish

50

Product Code	Watts (W)	Volts (V)	Cap	Colour Appearance	Colour Temp (K)	Total Lumens (lm)	Incandescent Equivalent (W)	Dimensions (mm)	Energy Rating	Order Qty
								Dia H		
Single Carton										
5938	5	240	BC-B22d	Warm White	2700	470	40	60 102	A+	10
5945	5	240	ES-E27	Warm White	2700	470	40	60 104	A+	10
5952	7.5	240	BC-B22d	Warm White	2700	806	60	60 102	A+	10
5969	7.5	240	ES-E27	Warm White	2700	806	60	60 104	A+	10

* The lamp is compatible with most dimmer switches, please refer to website for up-to-date list of compatible dimmer switches.

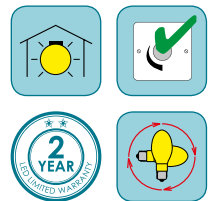
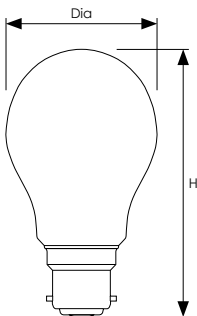



LED Filament Candle/Round Pearl Dimmable & Non-Dimmable



Energy saving LED replacement lamp featuring LED filament technology to closely resemble the look and feel of a traditional pearl incandescent lamp.

- 10,000 hour life
- 5,000 switching cycles
- 2700K warm white
- Colour rendering index Ra≥80
- BC-B22d, ES-E27, SBC-B15d cap and SES-E14 cap
- Pearl finish
- Dimmable or non-dimmable options
- Dimmable option utilizes DuoDim™ Technology compatible with both leading and trailing edge dimmers*
- Recommended for indoor use only



51

Product Code	Watts (W)	Volts (V)	Cap	Colour Appearance	Colour Temp (K)	Total Lumens (lm)	Incandescent Equivalent (W)	Dimensions (mm)		Energy Rating	Order Qty
								Dia	H		
Dimmable Candle - Single Carton											
7178	5	240	BC-B22d	Warm White	2700	470	40	35	91	A+	10
7185	5	240	SBC-B15d	Warm White	2700	470	40	35	95	A+	10
7192	5	240	ES-E27	Warm White	2700	470	40	35	93	A+	10
7208	5	240	SES-E14	Warm White	2700	470	40	35	97	A+	10
Non-Dimmable Round - Single Carton											
6003	4	240	ES-E27	Warm White	2700	470	40	45	78	A+	10
6010	4	240	SES-E14	Warm White	2700	470	40	45	80	A+	10
Dimmable Round - Single Carton											
7253	5	240	BC-B22d	Warm White	2700	470	40	45	76	A+	10
7260	5	240	SBC-B15d	Warm White	2700	470	40	45	78	A+	10
7277	5	240	ES-E27	Warm White	2700	470	40	45	78	A+	10
7284	5	240	SES-E14	Warm White	2700	470	40	45	80	A+	10

* The lamp is compatible with most dimmer switches, please refer to website for up-to-date list of compatible dimmer switches.

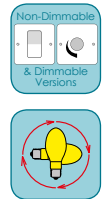
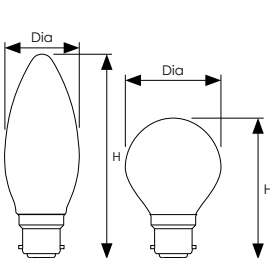



LED Filament Antique Bronze Dimmable



Energy saving LED replacement lamp featuring LED filament technology and antique bronzed coloured glass to closely resemble the look and feel of a traditional Antique filament incandescent lamp.

- 10,000 hour life
- 5,000 switching cycles
- Available in 5W or 7.5W (ST64 & G125)
- 2200K extra warm white
- Colour rendering index Ra≥80
- BC-B22d or ES-E27 cap
- Antique bronze finish
- Dimmable - DuoDim™ Technology compatible with both leading and trailing edge dimmers*
- Recommended for indoor use only

52

Product Code	Watts (W)	Volts (V)	Cap	Colour Appearance	Colour Temp (K)	Total Lumens (lm)	Incandescent Equivalent (W)	Dimensions (mm)		Energy Rating	Order Qty
								Dia	H		
ST64 - Single Carton											
4221	5	240	BC-B22d	Extra Warm White	2200	410	35	64	138	A+	1
4238	5	240	ES-E27	Extra Warm White	2200	410	35	64	140	A+	1
4245	7.5	240	BC-B22d	Extra Warm White	2200	638	50	64	138	A+	1
4252	7.5	240	ES-E27	Extra Warm White	2200	638	50	64	140	A+	1
G80 - Single Carton											
4269	5	240	BC-B22d	Extra Warm White	2200	410	35	80	120	A+	1
4276	5	240	ES-E27	Extra Warm White	2200	410	35	80	122	A+	1
G95 - Single Carton											
4283	5	240	BC-B22d	Extra Warm White	2200	410	35	95	138	A+	1
4290	5	240	ES-E27	Extra Warm White	2200	410	35	95	138	A+	1
G125 - Single Carton											
4306	7.5	240	BC-B22d	Extra Warm White	2200	638	50	125	175	A+	1
4313	7.5	240	ES-E27	Extra Warm White	2200	638	50	125	175	A+	1

* The lamp is compatible with most dimmer switches, please refer to website for up-to-date list of compatible dimmer switches.

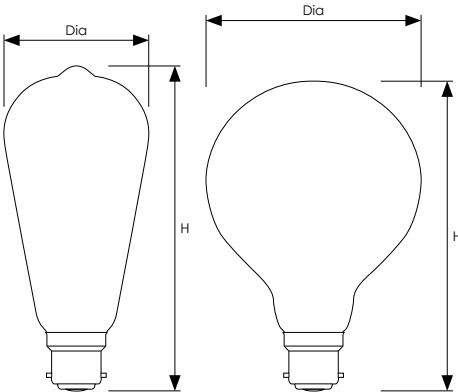

View on Youtube





LED Spiral Filament Antique Bronze Dimmable



Energy saving LED replacement lamp featuring LED filament technology. LED spiral filaments FPC (flexible printed circuit) series filament arrangement, allowing true omni-directional light output. Full antique bronzed coloured glass to closely resemble the look and feel of a traditional Antique spiral filament incandescent lamp.

- 15,000 hour life
- 7,500 switching cycles
- 2200K extra warm white
- Colour rendering index Ra≥80
- BC-B22d or ES-E27 cap
- Antique bronze finish
- Dimmable - DuoDim™ Technology compatible with both leading and trailing edge dimmers*
- Recommended for indoor use only



53

Product Code	Watts (W)	Volts (V)	Cap	Colour Appearance	Colour Temp (K)	Total Lumens (lm)	Incandescent Equivalent (W)	Dimensions (mm)		Energy Rating	Order Qty
								Dia	H		
ST64 - Single Carton											
6591	6	240	BC-B22d	Extra Warm White	2200	250	25	64	138	A	1
6607	6	240	ES-E27	Extra Warm White	2200	250	25	64	140	A	1
G80 - Single Carton											
6614	6	240	BC-B22d	Extra Warm White	2200	250	25	80	120	A	1
6621	6	240	ES-E27	Extra Warm White	2200	250	25	80	122	A	1

* The lamp is compatible with most dimmer switches, please refer to website for up-to-date list of compatible dimmer switches.

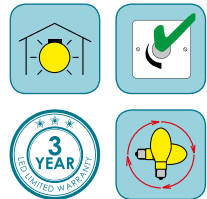
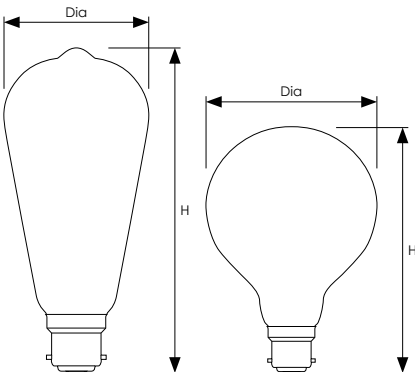



LED GLS Thermal Plastic

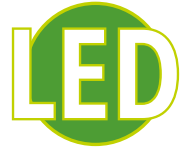

LED GLS replacement lamp. Lightweight thermal plastic heat dissipating body and opal lens. True retrofit replacements for incandescent lamps.

- 15,000 hour life
- 30,000 switching cycles
- Exact equivalent brightness for regular 40W, 60W, 75W or 100W incandescent GLS lamps
- 2700K warm white, 4000K cool white or 6500K daylight colour options
- Colour rendering index Ra≥80
- BC-B22d or ES-E27 cap
- Opal finish
- Not suitable for dimming
- Recommended for indoor use only

Product Code	Watts (W)	Volts (V)	Cap	Colour Appearance	Colour Temp (K)	Total Lumens (lm)	Incandescent Equivalent (W)	Dimensions (mm)		Energy Rating	Order Qty
								Dia	H		
40W Equivalent - Single Carton											
11694	5.5	240	BC-B22d	Warm White	2700	470	40	60	112	A+	10
11700	5.5	240	ES-E27	Warm White	2700	470	40	60	112	A+	10
60W Equivalent - Single Carton											
11717	8.5	240	BC-B22d	Warm White	2700	806	60	60	112	A+	10
11724	8.5	240	ES-E27	Warm White	2700	806	60	60	112	A+	10
11731	8.5	240	BC-B22d	Cool White	4000	806	60	60	112	A+	10
11748	8.5	240	ES-E27	Cool White	4000	806	60	60	112	A+	10
75W Equivalent - Single Carton											
11755	11	240	BC-B22d	Warm White	2700	1055	75	60	120	A+	10
11762	11	240	ES-E27	Warm White	2700	1055	75	60	120	A+	10
11779	11	240	BC-B22d	Cool White	4000	1055	75	60	120	A+	10
11786	11	240	ES-E27	Cool White	4000	1055	75	60	120	A+	10
11793	11	240	BC-B22d	Daylight	6500	1055	75	65	120	A+	10
11809	11	240	ES-E27	Daylight	6500	1055	75	60	120	A+	10
100W Equivalent - Single Carton											
11878	15	240	BC-B22d	Warm White	2700	1521	100	65	120	A+	10
11885	15	240	ES-E27	Warm White	2700	1521	100	65	120	A+	10

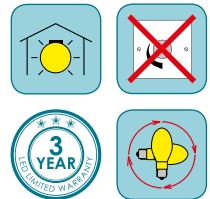
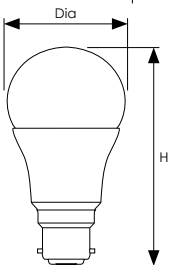



LED GLS Thermal Plastic Dimmable



LED GLS dimmable replacement lamp. Lightweight thermal plastic heat dissipating body and opal lens. Fully dimmable. True retrofit replacements for 75W & 100W incandescent lamp.

- 15,000 hour life
- 30,000 switching cycles
- Exact equivalent for 75W/100W incandescent GLS lamp
- 2700K warm white or 4000K cool white or 6500K daylight colour options
- Colour rendering index Ra≥80
- BC-B22d or ES-E27 cap
- Opal finish
- Dimmable - DuoDim™ Technology compatible with both leading and trailing edge dimmers*
- Recommended for indoor use only



Product Code	Watts (W)	Volts (V)	Cap	Colour Appearance	Colour Temp (K)	Total Lumens (lm)	Incandescent Equivalent (W)	Dimensions (mm)		Energy Rating	Order Qty
								Dia	H		
75W Equivalent - Single Carton											
11816	11	240	BC-B22d	Warm White	2700	1055	75	65	120	A+	10
11823	11	240	ES-E27	Warm White	2700	1055	75	60	120	A+	10
11830	11	240	BC-B22d	Cool White	4000	1055	75	65	120	A+	10
11847	11	240	ES-E27	Cool White	4000	1055	75	65	120	A+	10
11854	11	240	BC-B22d	Daylight	6500	1055	75	65	120	A+	10
11861	11	240	ES-E27	Daylight	6500	1055	75	65	120	A+	10
100W Equivalent - Single Carton											
11892	14	240	BC-B22d	Warm White	2700	1521	100	65	120	A+	10
11908	14	240	ES-E27	Warm White	2700	1521	100	70	128	A+	10

* The lamp is compatible with most dimmer switches, please refer to website for up-to-date list of compatible dimmer switches.

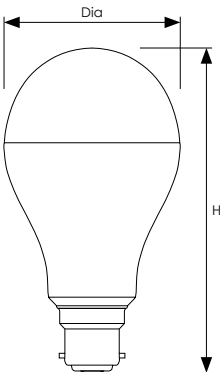



LED Candle Thermal Plastic



LED candle replacement lamp. Lightweight thermal plastic heat dissipating body and opal lens. True retrofit replacement for incandescent lamps.

- 25,000 hour life
- 15,000 switching cycles
- Exact equivalent brightness for regular 40W incandescent candle lamps
- 2700K warm white, 4000K cool white or 6500K daylight colour options
- Colour rendering index Ra≥80
- BC-B22d, SBC-B15d, ES-E27 or SES-E14 caps
- Opal finish
- Not suitable for dimming
- Recommended for indoor use only

Product Code	Watts (W)	Volts (V)	Cap	Colour Appearance	Colour Temp (K)	Total Lumens (lm)	Incandescent Equivalent (W)	Dimensions (mm)		Energy Rating	Order Qty
								Dia	H		
Single Carton											
11298	5.5	240	BC-B22d	Warm White	2700	470	40	37	95	A+	10
11304	5.5	240	SBC-B15d	Warm White	2700	470	40	37	98	A+	10
11311	5.5	240	ES-E27	Warm White	2700	470	40	37	96	A+	10
11328	5.5	240	SES-E14	Warm White	2700	470	40	37	100	A+	10
11335	5.5	240	BC-B22d	Cool White	4000	470	40	37	95	A+	10
11342	5.5	240	ES-E27	Cool White	4000	470	40	37	96	A+	10
11359	5.5	240	SES-E14	Cool White	4000	470	40	37	100	A+	10
11366	5.5	240	BC-B22d	Daylight	6500	470	40	37	95	A+	10
11373	5.5	240	ES-E27	Daylight	6500	470	40	37	96	A+	10
11380	5.5	240	SES-E14	Daylight	6500	470	40	37	100	A+	10

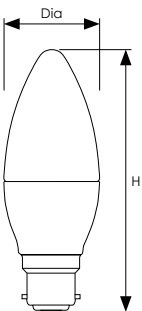

BC-B22d Cap



ES-E27 Cap



SBC-B15d Cap



SES-E14 Cap





LED Candle Dimmable Thermal Plastic



LED candle dimmable replacement lamp. Lightweight thermal plastic heat dissipating body and opal lens. True retrofit replacement for incandescent lamps.

- Up to 25,000 hour life
- Up to 50,000 switching cycles
- Exact equivalent brightness for regular 40W incandescent candle lamps
- 2700K warm white, 4000K cool white or 6500K daylight colour options
- Colour rendering index Ra≥80
- BC-B22d , SBC-B15d, ES-E27 or SES-E14 caps
- Opal finish
- Dimmable - DuoDim™ Technology compatible with both leading and trailing edge dimmers*
- Recommended for indoor use only



Product Code	Watts (W)	Volts (V)	Cap	Colour Appearance	Colour Temp (K)	Total Lumens (lm)	Incandescent Equivalent (W)	Dimensions (mm)		Energy Rating	Order Qty
								Dia	H		
Single Carton											
13476 [†]	5.5	240	BC-B22d	Warm White	2700	470	40	35	100	A+	10
14558 [†]	5.5	240	SBC-B15d	Warm White	2700	470	40	37	108	A+	10
9226	5.5	240	ES-E27	Warm White	2700	470	40	35	100	A+	10
13490 [†]	5.5	240	SES-E14	Warm White	2700	470	40	37	108	A+	10
9240	5.5	240	BC-B22d	Cool White	4000	470	40	35	100	A+	10
13513 [†]	5.5	240	ES-E27	Cool White	4000	470	40	37	107	A+	10
13520 [†]	5.5	240	SES-E14	Cool White	4000	470	40	37	100	A+	10
9271	5.5	240	BC-B22d	Daylight	6500	470	40	35	100	A+	10
9288	5.5	240	ES-E27	Daylight	6500	470	40	35	100	A+	10
13551 [†]	5.5	240	SES-E14	Daylight	6500	470	40	37	108	A+	10

* The lamp is compatible with most dimmer switches, please refer to website for up-to-date list of compatible dimmer switches.
 † 2 Years warranty on marked lamps

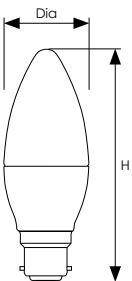

BC-B22d Cap



ES-E27 Cap



SBC-B15d Cap



SES-E14 Cap





LED Round Thermal Plastic



LED round replacement lamp. Lightweight thermal plastic heat dissipating body and opal lens. True retrofit replacement for incandescent lamps.



- 25,000 hour life
- 15,000 switching cycles
- Exact equivalent brightness for regular 40W incandescent round lamps
- 2700K warm white, 4000K cool white or 6500K daylight colour options
- Colour rendering index Ra≥80
- BC-B22d, SBC-B15d, ES-E27 or SES-E14 caps
- Opal finish
- Not suitable for dimming
- Recommended for indoor use only

Product Code	Watts (W)	Volts (V)	Cap	Colour Appearance	Colour Temp (K)	Total Lumens (lm)	Incandescent Equivalent (W)	Dimensions (mm)		Energy Rating	Order Qty
								Dia	H		
Single Carton											
11496	5.5	240	BC-B22d	Warm White	2700	470	40	45	82	A+	10
11502	5.5	240	SBC-B15d	Warm White	2700	470	40	45	82	A+	10
11519	5.5	240	ES-E27	Warm White	2700	470	40	45	83	A+	10
11526	5.5	240	SES-E14	Warm White	2700	470	40	45	83	A+	10
11533	5.5	240	BC-B22d	Cool White	4000	470	40	45	82	A+	10
11540	5.5	240	ES-E27	Cool White	4000	470	40	45	83	A+	10
11557	5.5	240	SES-E14	Cool White	4000	470	40	45	83	A+	10
11564	5.5	240	BC-B22d	Daylight	6500	470	40	45	82	A+	10
11571	5.5	240	ES-E27	Daylight	6500	470	40	45	83	A+	10
11588	5.5	240	SES-E14	Daylight	6500	470	40	45	83	A+	10

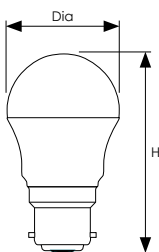

BC-B22d Cap



ES-E27 Cap



SBC-B15d Cap



SES-E14 Cap





LED Round Dimmable Thermal Plastic



LED round dimmable replacement lamp. Lightweight thermal plastic heat dissipating body and opal lens. True retrofit replacement for incandescent lamps.

- Up to 25,000 hour life
- Up to 50,000 switching cycles
- Exact equivalent brightness for regular 40W incandescent round lamps
- 2700K warm white, 4000K cool white or 6500K daylight colour options
- Colour rendering index Ra≥80
- BC-B22d , SBC-B15d, ES-E27 or SES-E14 caps
- Opal finish
- Dimmable - DuoDim™ Technology compatible with both leading and trailing edge dimmers*
- Recommended for indoor use only



59

Product Code	Watts (W)	Volts (V)	Cap	Colour Appearance	Colour Temp (K)	Total Lumens (lm)	Incandescent Equivalent (W)	Dimensions (mm)		Energy Rating	Order Qty
								Dia	H		
Single Carton											
9301	5.5	240	BC-B22d	Warm White	2700	470	40	45	84	A+	10
9318	5.5	240	SBC-B15d	Warm White	2700	470	40	45	89	A+	10
9325	5.5	240	ES-E27	Warm White	2700	470	40	45	84	A+	10
9332	5.5	240	SES-E14	Warm White	2700	470	40	45	89	A+	10
9349	5.5	240	BC-B22d	Cool White	4000	470	40	45	84	A+	10
13605†	5	240	ES-E27	Cool White	4000	470	40	45	77	A+	10
13612†	5	240	SES-E14	Cool White	4000	470	40	45	82	A+	10
9370	5.5	240	BC-B22d	Daylight	6500	470	40	45	84	A+	10
9387	5.5	240	ES-E27	Daylight	6500	470	40	45	84	A+	10
9394	5.5	240	SES-E14	Daylight	6500	470	40	45	89	A+	10

* The lamp is compatible with most dimmer switches, please refer to website for up-to-date list of compatible dimmer switches.
 † 2 Years warranty on marked lamps

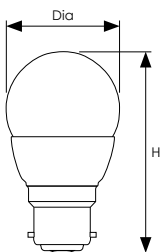



LED Reflector Thermal Plastic



LED reflector replacement lamps shaped and sized similar to R39, R50, R63 or R80 reflector lamps. Lightweight thermal plastic heat dissipating body and opal lens. True retrofit replacement for incandescent lamps.

- Equivalent brightness for regular incandescent reflector lamps
- 20,000 hour life
- 10,000 switching cycles
- 2700K warm white
- Colour rendering index Ra≥80
- BS-B22d, SES-E14 or ES-E27 cap
- Opal finish
- Not suitable for dimming
- Recommended for indoor use only

60

Product Code	Watts (W)	Volts (V)	Cap	Colour Appearance	Colour Temp (K)	Useful Lumens (lm)	Total Lumens (lm)	Beam Angle	Dimensions (mm)		Energy Rating	Order Qty
									Dia	H		
R39 - Single Carton												
12707	3	240	SES-E14	Warm White	2700	150	210	110°	39	69	A	10
R50 - Single Carton												
12714	6	240	SES-E14	Warm White	2700	335	450	110°	50	85	A	10
R63 - Single Carton												
7307	6	240	BC-B22d	Warm White	2700	370	470	100°	63	97	A	10
12721	8	240	ES-E27	Warm White	2700	450	600	110°	63	100	A	10
R80 - Single Carton												
12738	9.5	240	ES-E27	Warm White	2700	580	800	110°	80	114	A	10

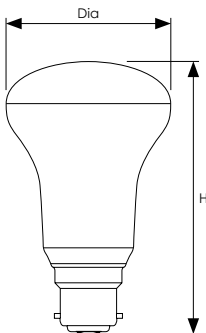



LED 110V GLS Thermal Plastic



LED 110V special purpose GLS replacement lamp for use in industrial applications. Lightweight thermal plastic heat dissipating body and opal lens. True retrofit replacement for incandescent lamps.

- 20,000 hour life
- 10,000 switching cycles
- Exact equivalent brightness for regular 60W incandescent GLS lamps
- 2700K warm white or 4000K cool white
- Colour rendering index Ra≥80
- BC-B22d or ES-E27 cap
- Opal finish with site safe yellow body
- Not suitable for dimming
- Recommended for indoor use only



61

Product Code	Watts (W)	Volts (V)	Cap	Colour Appearance	Colour Temp (K)	Total Lumens (lm)	Incandescent Equivalent (W)	Dimensions (mm)		Energy Rating	Order Qty
								Dia	H		
Single Carton											
11915	9	110	BC-B22d	Warm White	2700	806	60	60	112	A+	1
11922	9	110	ES-E27	Warm White	2700	806	60	60	112	A+	1
12042	9	110	BC-B22d	Cool White	4000	806	60	60	112	A+	1

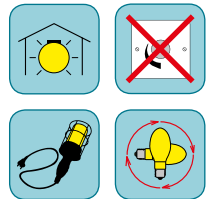
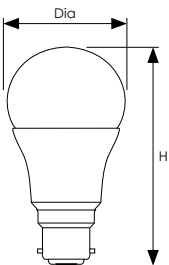



LED GLS Dusk till Dawn

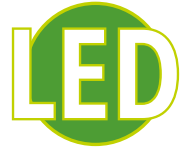

Energy saving LED GLS lamp with dusk till dawn sensor which automatically illuminates during periods of low light and turns off in daylight. The sensor (specifically designed to detect ultra violet light) is mounted on the internal tray within the dome of the lamp. This gives the lamp an excellent detection range and eliminates positioning issues during installation.

- 25,000 hour life
- 12,500 switching cycles
- Lightweight thermal plastic heat dissipating body and opal lens.
- Exact equivalent brightness for regular 60W incandescent GLS lamp
- 2700K warm white
- Colour rendering index Ra≥80
- BC-B22d or ES-E27 cap
- Opal finish
- Not suitable for dimming
- For outdoor use only in a suitable IP65 rated fitting

62

Product Code	Watts (W)	Volts (V)	Cap	Colour Appearance	Colour Temp (K)	Total Lumens (lm)	Incandescent Equivalent (W)	Dimensions (mm)		Energy Rating	Order Qty
								Dia	H		
Single Carton											
9615	9.5	240	BC-B22d	Warm White	2700	806	60	60	110	A+	1

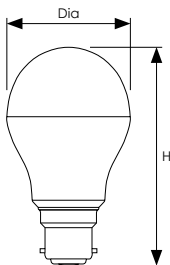



LED Thermal Plastic Stick Lamp



Energy saving LED thermal plastic stick lamp. Lightweight thermal plastic heat dissipating body and opal lens. True retrofit replacements for incandescent lamps. The lamps narrow shape makes it ideal for retrofit into smaller luminaires.

- 15,000 hour life
- 30,000 switching cycles
- 3000K warm white colour temperature
- Polycarbonate lens with an opal finish
- Highly diffused for a smooth even light
- Colour rendering index Ra≥80
- Exact equivalent brightness for regular 60W incandescent lamps
- BC-B22d and ES-E27 caps
- Not suitable for dimming
- Recommended for indoor use only



63

Product Code	Watts (W)	Volts (V)	Cap	Colour Appearance	Colour Temp (K)	Total Lumens (lm)	Incandescent Equivalent (W)	Dimensions (mm)		Energy Rating	Order Qty
								Dia	H		
Non-Dimmable Candle - Single Carton											
11144	7.5	240	BC-B22d	Warm White	3000	806	60	37	124	A+	1
11151	7.5	240	ES-E27	Warm White	3000	806	60	37	126	A+	1

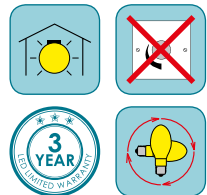
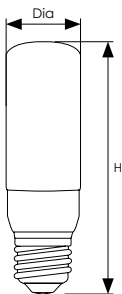



LED Filament Coloured Harlequin GLS



LED filament coloured harlequin GLS shaped translucent lamp, available in a choice of vibrant colours. The coating is applied internally and is fade resistant. The lamps are IP65 rated and when used with an IP65 rated socket they are ideal for outdoor applications where dirt and dust is encountered such as decorative strings and Christmas trees. They are also suitable for internal use.

- Internally coated for fade resistant vibrant colour
- 15,000 hour life
- 20,000 switching cycles
- Choice of blue, green, orange, pink, purple, red, white and yellow
- BC-B22d or ES-E27 cap
- IP65 rated; can be used outdoors in a suitable IP65 rated socket
- Not suitable for dimming

Product Code	Watts (W)	Volts (V)	Cap	Finish	Dimensions (mm)		Energy Rating	Order Qty
					Dia	H		
Single Carton								
13650	4.5	240	BC-B22d	Blue	60	102	B	1
13667	4.5	240	ES-E27	Blue	60	104	B	1
13674	4.5	240	BC-B22d	Green	60	102	A**	1
13681	4.5	240	ES-E27	Green	60	104	A**	1
13698	4.5	240	BC-B22d	Orange	60	102	A*	1
13704	4.5	240	ES-E27	Orange	60	104	A*	1
13711	4.5	240	BC-B22d	Pink	60	102	A	1
13728	4.5	240	ES-E27	Pink	60	104	A	1
13735	4.5	240	BC-B22d	Purple	60	102	A*	1
13742	4.5	240	ES-E27	Purple	60	104	A*	1
13759	4.5	240	BC-B22d	Red	60	102	B	1
13766	4.5	240	ES-E27	Red	60	104	B	1
13773	4.5	240	BC-B22d	White	60	102	A**	1
13780	4.5	240	ES-E27	White	60	104	A**	1
13797	4.5	240	BC-B22d	Yellow	60	102	A**	1
13803	4.5	240	ES-E27	Yellow	60	104	A**	1

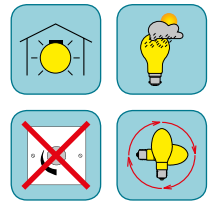
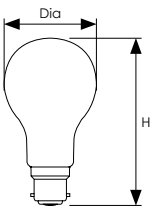



LED Filament Coloured Harlequin Round



LED filament coloured harlequin Round shaped translucent lamp, available in a choice of vibrant colours. The coating is applied internally and is fade resistant. The lamps are IP65 rated and when used with an IP65 rated socket they are ideal for outdoor applications where dirt and dust is encountered such as decorative strings and Christmas trees. They are also suitable for internal use.

- Internally coated for fade resistant vibrant colour
- 15,000 hour life
- 20,000 switching cycles
- Choice of blue, green, orange, pink, purple, red, white and yellow
- BC-B22d or ES-E27 cap
- IP65 rated; can be used outdoors in a suitable IP65 rated socket
- Not suitable for dimming



65

Product Code	Watts (W)	Volts (V)	Cap	Finish	Dimensions (mm)		Energy Rating	Order Qty
					Dia	H		
Single Carton								
13810	4.5	240	BC-B22d	Blue	45	76.5	B	1
13827	4.5	240	ES-E27	Blue	45	78	B	1
13834	4.5	240	BC-B22d	Green	45	76.5	A**	1
13841	4.5	240	ES-E27	Green	45	78	A**	1
13858	4.5	240	BC-B22d	Orange	45	76.5	A*	1
13865	4.5	240	ES-E27	Orange	45	78	A*	1
13872	4.5	240	BC-B22d	Pink	45	76.5	A	1
13889	4.5	240	ES-E27	Pink	45	78	A	1
13896	4.5	240	BC-B22d	Purple	45	76.5	A*	1
13902	4.5	240	ES-E27	Purple	45	78	A*	1
13919	4.5	240	BC-B22d	Red	45	76.5	B	1
13926	4.5	240	ES-E27	Red	45	78	B	1
13933	4.5	240	BC-B22d	White	45	76.5	A**	1
13940	4.5	240	ES-E27	White	45	78	A**	1
13957	4.5	240	BC-B22d	Yellow	45	76.5	A**	1
13964	4.5	240	ES-E27	Yellow	45	78	A**	1

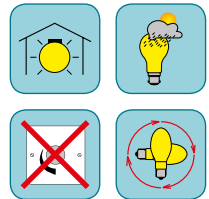
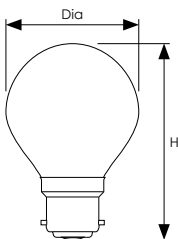



LED Coloured GU10



LED Coloured GU10 lamp, available in vibrant red and yellow colours. The coating is applied internally and is fade resistant.



- 15,000 hour life
- 10,000 switching cycles
- 35° beam angle
- Instant full light
- Great for use in bars and restaurants, hotels etc
- Not suitable for dimming
- Recommended for indoor use only

66

Product Code	Watts (W)	Volts (V)	Cap	Finish	Dimensions (mm)		Energy Rating	Order Qty
					Dia	H		
Single Carton								
9479	4.5	240	GU10	Red	50	56		1
9486	4.5	240	GU10	Yellow	50	56		1

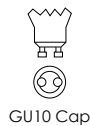
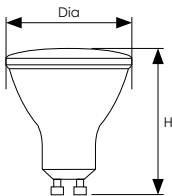



LED Coloured Sign



Low energy LED coloured sign lamp with a solid colour finish internally applied for durability. Full glass housing. IP65 rated for use outdoors (only in a suitable IP65 rated socket).

- 25,000 hour rated life
- 50,000 switching cycles
- Energy saving LED Coloured Sign/Pygmy - ideal for retrofit
- Internally coated for fade resistant vibrant colour
- IP65 rated, can be used in a suitable IP65 socket
- Instant full light
- Not suitable for dimming



Product Code	Watts (W)	Volts (V)	Cap	Finish	Dimensions (mm)		Energy Rating	Order Qty
					Dia	H		
Single Carton								
9066	1.3	240	SES-E14	Amber	25	60	A	1
9073	1.3	240	SES-E14	Blue	25	60	C	1
9080	1.3	240	SES-E14	Green	25	60	B	1
9097	1.3	240	SES-E14	Red	25	60	B	1
9103	1.3	240	SES-E14	Yellow	25	60	A*	1
12820	2.7	240	SES-E14	White	26	62	A**	1

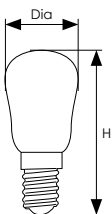

SES-E14 Cap



View on Youtube





LED Coloured PAR38



LED PAR (Pressed Aluminium Reflector) lamps feature a glass enclosure and highly reflective aluminium coating applied internally.

- 15,000 hour life
- 30,000 switching cycles
- ES-E27 cap
- Prismatic lens
- Available in a variety of colours
- Not suitable for dimming
- IP65 rated - Suitable for outdoor use

Product Code	Watts (W)	Volts (V)	Cap	Colour Appearance	Colour Temp (K)	Useful Lumens (lm)	Total Lumens (lm)	Halogen Equiv. (W)	Beam Angle	Dimensions (mm)	Energy Rating	Order Qty
										Dia H		
Single Carton												
4504	13	240	ES-E27	Red				110	30°	123 132	B	1
4511	13	240	ES-E27	Yellow				110	30°	123 132	A	1
4528	13	240	ES-E27	Blue				110	30°	123 132	E	1

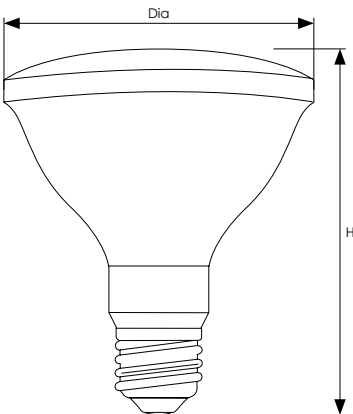



LED PAR30 and PAR38 Dimmable



LED PAR (Pressed Aluminium Reflector) lamps feature a glass enclosure and highly reflective aluminium coating applied internally.

- 25,000 hour life
- 12,500 switching cycles
- ES-E27 cap
- Colour rendering index Ra≥80
- Prismatic lens
- DuoDim™ Technology compatible with both leading and trailing edge dimmers*
- IP65 rated for outdoor wet weather use when fitted in an IP65 rated fitting



Product Code	Watts (W)	Volts (V)	Cap	Colour Appearance	Colour Temp (K)	Useful Lumens (lm)	Total Lumens (lm)	Halogen Equiv. (W)	Beam Angle	Dimensions (mm)		Energy Rating	Order Qty
										Dia	H		
PAR30 Dimmable* - Single Carton													
12752	10	240	ES-E27	Warm White	3000	800	1000	100	45°	95	92	A+	1
PAR38 Dimmable* - Single Carton													
12745	18	240	ES-E27	Warm White	3000	1400	1700	120	45°	131	122	A+	1

* The lamps are compatible with most dimmer switches, please refer to website for up-to-date list of compatible dimmer switches.

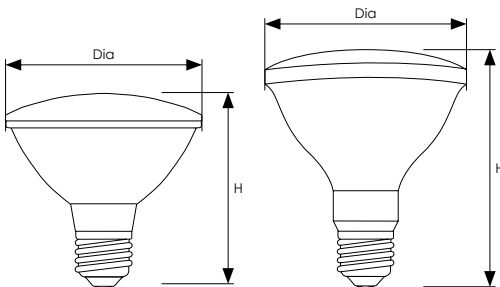



LED Thermal Plastic GU10 SMD

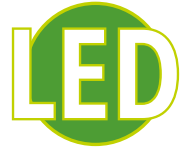

Energy efficient LED GU10 lamp with thermal plastic heat dissipating body. Suitable for fire rated downlights.

- 15,000 hour life
- 30,000 switching cycles
- 3000K warm white or 4000K cool white colour options
- Colour rendering index Ra≥80
- GU10 cap
- Suitable for fire rated downlights
- Not suitable for dimming
- Recommended for indoor use only



70

Product Code	Watts (W)	Volts (V)	Cap	Colour Appearance	Colour Temp (K)	Useful Lumens (lm)	Total Lumens (lm)	Halogen Equiv. (W)	Beam Angle	Dimensions (mm)		Energy Rating	Order Qty
										Dia	H		
Single Carton													
11229	5	240	GU10	Warm White	3000	330	380	50	38°	50	53	A+	10
11236	5	240	GU10	Cool White	4000	340	390	50	38°	50	53	A+	10

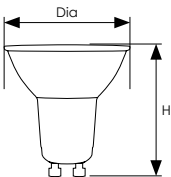

GU10 Cap





LED Glass GU10 SMD Dimmable and Non-Dimmable



Energy efficient LED GU10 lamp with glass body. Suitable for fire rated downlights.

- 15,000 hour life
- 10,000 switching cycles
- 2700K warm white or 4000K cool white colour options
- Colour rendering index Ra≥80
- GU10 cap
- Suitable for fire rated downlights
- Dimmable or non-dimmable options
- Dimmable option utilizes DuoDim™ Technology compatible with both leading and trailing edge dimmers*
- Recommended for indoor use only



71

Product Code	Watts (W)	Volts (V)	Cap	Colour Appearance	Colour Temp (K)	Useful Lumens (lm)	Total Lumens (lm)	Halogen Equiv. (W)	Beam Angle	Dimensions (mm)		Energy Rating	Order Qty
										Dia	H		
Dimmable* - Single Carton													
6102	5	240	GU10	Warm White	2700	360	390	50	35°	50	56	A+	10
6119	5	240	GU10	Cool White	4000	390	420	50	35°	50	56	A+	10
Non-Dimmable - Single Carton													
4870	4.5	240	GU10	Warm White	2700	340	380	50	35°	50	53	A+	10
4887	4.5	240	GU10	Cool White	4000	360	400	50	35°	50	53	A+	10

* The lamp is compatible with most dimmer switches, please refer to website for up-to-date list of compatible dimmer switches.

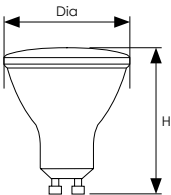



5W LED GU10 COB Dimmable and Non-Dimmable



LED retrofit lamp shaped and sized similar to a GU10 halogen lamp featuring the latest LED COB technology. Extremely low power consumption at 90lm/W.



- 30,000 hour life
- 15,000 switching cycles
- 3000K warm white, 4000K cool white or 6000K daylight colour options
- Colour rendering index Ra≥80
- GU10 cap
- Suitable for fire rated downlights
- Dimmable or non-dimmable options
- Dimmable option utilizes DuoDim™ Technology compatible with both leading and trailing edge dimmers*
- Recommended for indoor use only

72

Product Code	Watts (W)	Volts (V)	Cap	Colour Appearance	Colour Temp (K)	Useful Lumens (lm)	Total Lumens (lm)	Halogen Equiv. (W)	Beam Angle	Dimensions (mm)	Energy Rating	Order Qty
										Dia H		
Dimmable* - Single Carton												
LGU105WWCOB-DIM	5	240	GU10	Warm White	3000	450	520	50+	45°	50 55.5	A++	10
LGU105CWCOB-DIM	5	240	GU10	Cool White	4000	450	520	50+	45°	50 55.5	A++	10
LGU105DLCOB-DIM	5	240	GU10	Daylight	6000	450	520	50+	45°	50 55.5	A++	10
Non-Dimmable - Single Carton												
LGU105WWCOB	5	240	GU10	Warm White	3000	450	520	50+	45°	50 55.5	A++	10
LGU105CWCOB	5	240	GU10	Cool White	4000	450	520	50+	45°	50 55.5	A++	10
LGU105DLCOB	5	240	GU10	Daylight	6000	450	520	50+	45°	50 55.5	A++	10

* The lamp is compatible with most dimmer switches, please refer to website for up-to-date list of compatible dimmer switches.

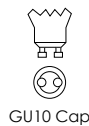
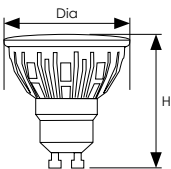



LED GU10 Glass SMD 5.5W Sunset Dim



LED retrofit GU10 sunset dimmable lamp, emits a warmer light when dimmed from 3000K to 2200K, simulating the characteristics of a traditional halogen lamp.

- 25,000 hour life
- 50,000 switching cycles
- Features Sunset Dim technology; as the lamp is dimmed the colour temperature becomes warmer to recreate the cosy feeling of a traditional halogen lamp
- 3000K warm white at full power; 2200K extra warm white when dimmed to 10%
- DuoDim™ Technology compatible with both leading and trailing edge dimmers*
- Suitable for fire rated downlights
- Ideal for bars, hotels and restaurants to create ambience and mood lighting
- Recommended for indoor use only
- Instant full light



73

Product Code	Watts (W)	Volts (V)	Cap	Colour Appearance	Colour Temp (K)	Useful Lumens (lm)	Total Lumens (lm)	Halogen Equiv. (W)	Beam Angle	Dimensions (mm)		Energy Rating	Order Qty
										Dia	H		
Single Carton													
9738	5.5	240	GU10	Warm White/ Extra Warm White	3000/ 2200	300	360	50	50°	50	54	A	1

* The lamp is compatible with most dimmer switches, please refer to website for up-to-date list of compatible dimmer switches.

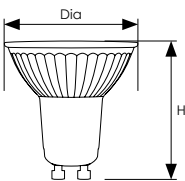



LED Long Barrel GU10 SMD



LED retrofit lamp featuring a long barrelled body which is designed to fit extra-deep L1/GU10 fittings. Features the latest low energy LED SMD technology.

- 25,000 hour life
- 12,500 switching cycles
- 2700K warm white or 4000K cool white colour options
- Colour rendering index Ra \geq 80
- GU10 cap with hole - compatible with all long barrel GU10 fittings including L1 low energy and TP24 fittings
- Suitable for fire rated downlights
- Not suitable for dimming
- Recommended for indoor use only

74



Product Code	Watts (W)	Volts (V)	Cap	Colour Appearance	Colour Temp (K)	Useful Lumens (lm)	Total Lumens (lm)	Halogen Equiv. (W)	Beam Angle	Dimensions (mm)		Energy Rating	Order Qty
										Dia	H		
Single Carton													
13452	5.5	240	L1/GU10	Warm White	2700	330	400	50	100°	50	74	A+	1
13469	5.5	240	L1/GU10	Cool White	4000	355	430	50	100°	50	74	A+	1

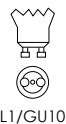
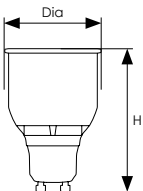



LED Glass 12V MR16 COB



LED retrofit MR16 lamp* featuring a full glass body to mimic the exact shape and size of a halogen MR16 lamp but featuring the latest low energy LED COB technology.

- 20,000 hour life
- 10,000 switching cycles
- 2700K warm white or 4000K cool white colour options
- Colour rendering index Ra≥80
- GU5.3 cap
- Suitable for fire rated downlights
- Not suitable for dimming
- Recommended for indoor use only



75

Product Code	Watts (W)	Volts (V)	Cap	Colour Appear.	Colour Temp (K)	Useful Lumens (lm)	Total Lumens (lm)	Halogen Equiv. (W)	Beam Angle	Dimensions (mm)		Energy Rating	Order Qty
										Dia	H		
Single Carton													
3293	5	12	GU5.3	Warm White	2700	350	380	35	40°	50	46	A+	10
3309	5	12	GU5.3	Cool White	4000	350	380	35	40°	50	46	A+	10

* Crompton 12V LED Glass MR16 lamps will operate with most AC or DC 12V transformers. However, some 12V transformers may have a minimum required load which may not be met when installing low powered LEDs; these transformers may cause flickering or the LEDs not to function correctly. If in doubt, Crompton Lamps can supply a suitable LED driver (Part number: LEDDRIVER10W) which is guaranteed to drive 1x 5W LED Glass MR16. Contact Crompton Lamps for more information or for prices of our LED Driver.

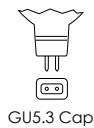
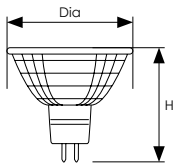



LED 12V MR11 SMD



High powered LED retrofit MR11 lamp* with extremely low power consumption and a lamp life of 25,000 hours.

- 25,000 hour life
- 12,500 switching cycles
- 2700K warm white or 4000K cool white colour options
- Colour rendering index Ra≥80
- GU4 cap
- Not suitable for dimming
- Recommended for indoor use only



76

Product Code	Watts (W)	Volts (V)	Cap	Colour Appear.	Colour Temp (K)	Useful Lumens (lm)	Total Lumens (lm)	Halogen Equiv. (W)	Beam Angle	Dimensions (mm)		Energy Rating	Order Qty
										Dia	H		
Single Carton													
5730	3.5	12	GU4	Warm White	2700	260	280	35	30°	35	40	A+	1
5747	3.5	12	GU4	Cool White	4000	280	300	35	30°	35	40	A+	1

* Crompton 12V LED MR11 lamps will operate with most AC or DC 12V transformers. However, some 12V transformers may have a minimum required load which may not be met when installing low powered LEDs; these transformers may cause flickering or the LEDs not to function correctly. If in doubt, Crompton Lamps can supply a suitable LED driver (Part number: LEDDRIVER10W) which is guaranteed to drive 2x 3.5W LED MR11. Contact Crompton Lamps for more information or for prices of our LED Driver.

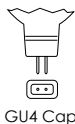
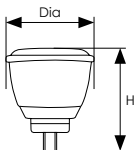



LED Miniatures Filament Cooker Hood and Pygmy/Sign/Fridge



Special purpose LED retrofit miniature lamps with extremely low power consumption.

LED Filament Cooker Hood

- 10,000 hour life, 50,000 switching cycles
- 2700K warm white or 4000K cool white colour options
- Colour rendering index Ra≥80
- Not suitable for dimming
- Recommended for indoor use only

LED Pygmy/Sign/Fridge

- 25,000 hour life, 50,000 switching cycles
- 2700K white
- Colour rendering index Ra≥80
- IP65 rated; can be used outdoors in a suitable IP65 rated socket
- Ambient operating temperature of -20°C to 30°C
- Not suitable for dimming
- Recommended for indoor use only



Product Code	Watts (W)	Volts (V)	Cap	Colour Appearance	Colour Temp (K)	Total Lumens (lm)	Incandescent Equivalent (W)	Dimensions (mm)		Energy Rating	Order Qty
								Dia	H		
Cooker Hood - Single Carton											
12837	3.8	240	SES-E14	Warm White	2700	440	40	26	90	A++	10
12844	3.8	240	SES-E14	Cool White	4000	440	40	26	90	A+	10
Pygmy/Sign/Fridge - Single Carton											
12820	2.7	240	SES-E14	White	2700	280	27	26	62	A++	10

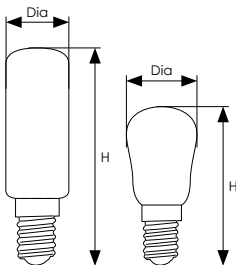



LED LED G4 Silicon LED G9 Capsule LED G9 Sunset Dim

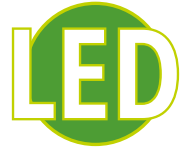

High efficiency LED G4* Silicon and G9 capsule lamps and G9 Sunset Dim A++ Energy Rated LED G9 Dimmable lamp for display and accent light fixtures.

- 6,000 hour life, 12,000 switching cycles
- 2700K warm white or 4000K cool white
- Colour rendering index Ra≥80
- G4 New design using clear silicone material
- G9 Lightweight plastic opaque casing
- Not suitable for dimming
- Recommended for indoor use only

G9 Sunset Dim

- 30,000 hour life, 50,000 switching cycles
- Features Sunset Dim technology; as the lamp is dimmed the colour temperature becomes warmer to recreate the cosy feeling of a traditional lamp
- 2800K warm white at full power; 2200K extra warm white when dimmed to 10%
- DuoDim™ Technology compatible with both leading and trailing edge dimmers
- Recommended for indoor use only

78

Product Code	Watts (W)	Volts (V)	Cap	Colour Appearance	Colour Temp (K)	Total Lumens (lm)	Energy Saving Halogen Equivalent (W)	Dimensions (mm) Dia H	Energy Rating	Order Qty
12V G4* - Single Carton										
7093	2	12	G4	Warm White	2700	190	10	10 37	A++	10
7109	2	12	G4	Cool White	4000	200	10	10 37	A++	10
240V G9 - Single Carton										
3415	2.5	240	G9	Warm White	2700	210	18	16.5 49	A++	10
3422	2.5	240	G9	Cool White	4000	210	18	16.5 49	A++	10
240V G9 Sunset Dim** - Single Carton										
9974	3	240	G9	2800K Warm White to 2200K Extra Warm White		300	28	17 58	A++	1

* Crompton 12V LED G4 lamps will operate with most 12V transformers. However, some 12V transformers may have a minimum required load which may not be met when installing low powered LEDs; these transformers may cause flickering or the LEDs not to function correctly. If in doubt, Crompton Lamps can supply a suitable LED driver (Part number: LEDDRIVER10W) which is guaranteed to drive 5x 2W LED G4. Contact Crompton Lamps for more information or for prices of our LED Driver.

** The lamp is compatible with most dimmer switches, please refer to website for up-to-date list of compatible dimmer switches.

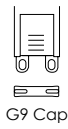
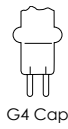
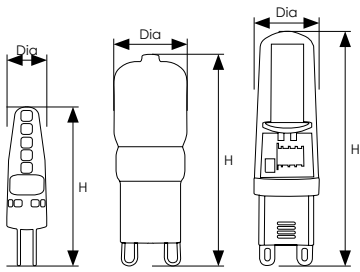

Sunset Dim Only

Sunset Dim Only



LED Linear R7s Lamps



Energy efficient LED linear retrofit lamp - an ideal replacement for halogen 78mm or 118mm linear lamps. Widely used in internal fittings such as mother & child floor lamps, up-lighters and ceiling lights.

- 20,000 hour life
- 50,000 switching cycles
- 6W/610lm/≈50W equivalent
- 9W/790lm/≈70W equivalent
- 3000K warm white colour temperature
- Colour rendering index Ra≥82
- R7s cap
- Not suitable for dimming
- Instant full light



Product Code	Watts (W)	Volts (V)	Cap	Colour Appearance	Colour Temp (K)	Total Lumens (lm)	Incandescent Equivalent (W)	Dimensions (mm)		Energy Rating	Order Qty
								Dia	L		
Non-Dimmable Candle - Single Carton											
10994	6	240	R7s	Warm White	3000	610	50	20	78	A+	1
11014	9	240	R7s	Warm White	3000	790	70	20	118	A+	1

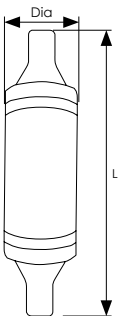

R7s Cap

Four icons in a 2x2 grid: top-left shows a lamp with a crossed-out dimmer symbol; top-right shows a lamp with a crossed-out halogen symbol; bottom-left shows a '3 YEAR WARRANTY' seal; bottom-right shows a recycling symbol.



LED PLL Direct to Mains



80



Energy saving LED PLL Direct to mains for maximum efficiency no ballast required* - ideal for multiple commercial applications. Featuring a full glass body with same dimensions as CFL PLL. No mercury or hazardous materials. Instant full light, with no warm-up time.

- 40,000 hour life
- 15,000 switching cycles
- 4000K cool white
- 280° beam angle
- Colour rendering index Ra≥80
- 2G11 cap
- Opal white finish
- Not suitable for dimming
- Not suitable for emergency circuits
- Recommended for indoor use only

Product Code	Watts (W)	Volts (V)	Cap	Colour Appearance	Colour Temp (K)	Total Lumens (lm)	CFL Equivalent (W)	Dimensions (mm)			Energy Rating	Order Qty
								Dia	H	L		
Single Carton												
12059	25	240	2G11	Cool White	4000	2700	55	43	24	541	A+	1

* Direct to mains only. Do not run with a ballast, re-wiring by a qualified person may be required, see website for instructions.

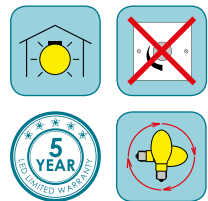
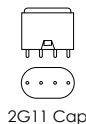



LED Double Ended Tubular



LED double ended tubular lamps for use in shaver lamps, picture lights and concealed lighting. Energy saving with low power consumption.

- 15,000 hour life
- 10,000 switching cycles
- 2700K warm white or 4000K cool white colour options
- Colour rendering index Ra≥80
- Opal finish
- Instant full light
- Standard 221mm or 284mm lengths
- Not suitable for dimming
- Recommended for indoor use only



Product Code	Watts (W)	Volts (V)	Cap	Colour Appearance	Colour Temp (K)	Total Lumens (lm)	Incandescent Equivalent (W)	Dimensions (mm)		Energy Rating	Order Qty
								Dia	H		
Single Carton											
5624	3.5	240	SCC-S15	Warm White	2700	300	30	26	221	A+	1
8854	3.5	240	SCC-S15	Cool White	4000	410	35	26	221	A+	1
5631	6	240	SCC-S15	Warm White	2700	500	40	26	284	A+	1
8861	6	240	SCC-S15	Cool White	4000	650	50	26	284	A+	1

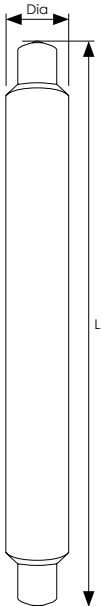

SCC-S15 Cap





LED Dimmable AR111 includes LED Driver



LED dimmable AR111 complete with LED driver. Energy saving with low power consumption. Typical uses include bars, restaurants, retail display and hotels.

- 35,000 hour life
- 17,500 switching cycles
- LED COB technology
- 2700K warm white or 4000K cool white colour options
- Colour rendering index Ra≥80
- Includes constant current LED driver**
- Dimmable - DuoDim™ Technology compatible with both leading and trailing edge dimmers***
- For use in display lighting
- Recommended for indoor use only

Product Code	Watts* (W)	Volts (V)	Colour Appearance	Colour Temp (K)	Useful Lumens (lm)	Total Lumens (lm)	Approx. Halogen Equiv. (W)	Beam Angle	Dimensions (mm)		Energy Rating	Order Qty
									Dia	H		
Single Carton												
3002	10	240	Warm White	2700	650	690	75	30°	110	43	A	1
3019	10	240	Cool White	4000	750	790	75	30°	110	43	A	1
3026	14	240	Warm White	2700	830	880	100	30°	110	43	A	1
3033	14	240	Cool White	4000	940	1000	100	30°	110	43	A	1

* For energy consumption, add 10% to rated power to calculate rated power correction for external LED driver.

** Lamp must be used in conjunction with included LED driver. LED driver 240V input voltage.

*** Lamp is compatible with most dimmer switches, please refer to website for up-to-date list of compatible dimmer switches.

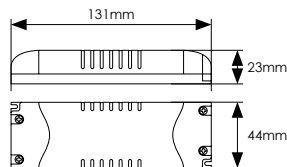
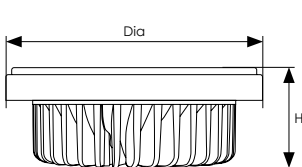



LED AR111 12.5W Direct Retrofit and AR111 GU10 Mains



LED AR111 Retrofit. Energy saving with low power consumption. Typical uses include bars, restaurants, retail display and hotels. For use in display lighting.

- 15,000 hour life
- 30,000 switching cycles
- Energy saving direct retrofit LED AR111
- Available as 12V G53 retrofit*, or with 240V GU10 cap
- 3000K warm white or 4000K cool white colour temperature
- Colour rendering index Ra≥80
- Exact shape and size as traditional halogen AR111
- Instant full light
- Recommended for indoor use only
- Not suitable for dimming



Product Code	Watts* (W)	Volts (V)	Cap	Colour Appearance	Colour Temp (K)	Useful Lumens (lm)	Total Lumens (lm)	Approx. Halogen Equiv. (W)	Beam Angle	Dimensions (mm) Dia H	Energy Rating	Order Qty
12V* Single Carton												
9127	12.5	12	G53	Warm White	3000	850	920	100	30°	111 62	A	1
9943	12.5	12	G53	Cool White	4000	870	940	100	30°	111 62	A	1
240V Single Carton												
9950	12.5	240	GU10	Warm White	3000	910	990	100	30°	111 62	A	1
9967	12.5	240	GU10	Cool White	4000	930	1010	100	30°	111 62	A	1

* Crompton 12V LED AR111 will operate with most AC or DC 12V transformers. However, some 12V transformers may have a minimum required load which may not be met when installing low powered LEDs; these transformers may cause flickering or the LEDs not to function correctly. If this issue arises it may be necessary to source a suitable LED Driver. If in doubt please contact Crompton Lamps for advice.

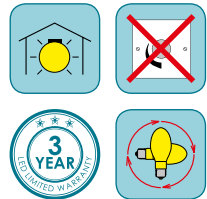
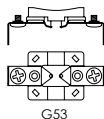
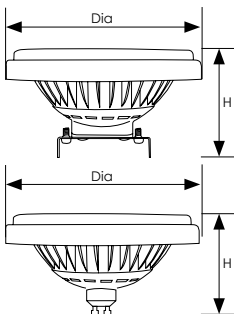



LED GX53



Energy saving LED GX53 retrofit lamp with extremely low power consumption. Opal finish. Not suitable for dimming.

- 25,000 hour life
- 12,500 switching cycles
- 2700K warm white or 4000K cool white colour options
- Colour rendering index Ra≥80
- Opal Finish
- For use in downlights and under kitchen cabinets, ideal for use in pantries and cloak-rooms
- Unique design produces all over illumination with no spotting
- Not suitable for dimming
- Recommended for indoor use only

84

Product Code	Watts (W)	Volts (V)	Cap	Colour Appearance	Colour Temp (K)	Useful Lumens (lm)	Total Lumens (lm)	CFL. Equiv. (W)	Beam Angle	Dimensions (mm)		Energy Rating	Order Qty
										Dia	H		
Single Carton													
12684	6	240	GX53	Warm White	2700	410	520	11	110°	75	25.5	A+	1
12691	6	240	GX53	Cool White	4000	420	540	11	110°	75	25.5	A+	1

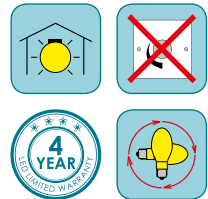
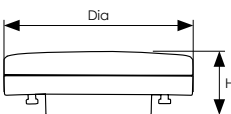



LED 2D Retrofit



Energy saving LED 2D Retrofit for direct replacement into most 2D fittings with no re-wiring*.

- 40,000 hour life
- 50,000 switching cycles
- 835 - 3500K white colour
- Colour rendering index Ra≥80
- Instant full light
- Not suitable for emergency lighting
- Not suitable for dimming
- Suitable for use outdoors when placed in a suitable IP65 rated fitting
- GR10q 4-Pin for use with high frequency electronic ballasts only



85

Product Code	Watts (W)	Cap	Colour Appearance	Colour Temp (K)	Total Lumens (lm)	Compact Fluorescent 2D Equivalent (W)	Dimensions (mm)		Energy Rating	Order Qty
							W	H		
Single Carton										
10222	16	GR10q 4-Pin	835 White	3500	1350	28	200	200	A	1

* See website for a list of compatible ballasts. The performance of this lamp is determined by the fitting to which it is installed.

N.B. Item is non-returnable
Crompton LED 2D Retrofit cannot be wired direct to 240V, lamp requires ballast to operate

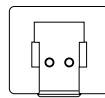
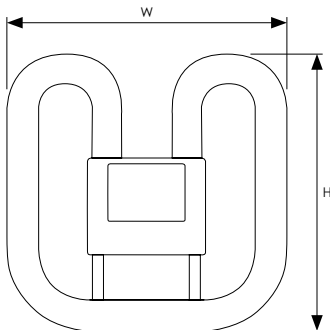

GR8 2 Pin Cap

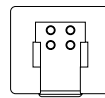

GR10q 4 Pin Cap





LED T8 Full Glass Tube

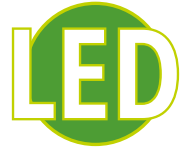

LED T8 full glass tube with internal diffused coating providing 320° light output. Energy saving with low power consumption. Includes LED starter for direct retrofit into existing single batten.*

- 40,000 hour life, 15,000 switching cycles
- 3000K warm white, 4000K cool white or 6500K daylight colour options
- Colour rendering index Ra≥80
- Standard 2ft, 3ft, 4ft 5ft or 6ft T8 lengths
- Ambient operating temperature -20°C to 50°C
- No mercury, no warping, no bending
- No discolouration of light over life of tube
- Not suitable for dimming
- Not suitable for emergency circuits
- Recommended for indoor use only
- Supplied in a rigid 2mm cardboard tube to minimise transportation damage

86

Product Code	Watts (W)	Volts (V)	Cap	Colour Appearance	Colour Temp (K)	Total Lumens (lm)	Beam Angle	Dimensions (mm)			Energy Rating	Order Qty
								Dia	L1	L2		
Single Carton												
LFT29WW	9	165-240	G13	Warm White	3000	800	320°	26	602	588	A+	1
LFT29CW	9	165-240	G13	Cool White	4000	810	320°	26	602	588	A+	1
LFT29DL	9	165-240	G13	Daylight	6500	900	320°	26	602	588	A+	1
LFT314WW	14	165-240	G13	Warm White	3000	1100	320°	26	906	894	A+	1
LFT314CW	14	165-240	G13	Cool White	4000	1200	320°	26	906	894	A+	1
LFT314DL	14	165-240	G13	Daylight	6500	1300	320°	26	906	894	A+	1
LFT422WW	22	165-240	G13	Warm White	3000	1950	320°	26	1212	1198	A+	1
LFT422CW	22	165-240	G13	Cool White	4000	2050	320°	26	1212	1198	A+	1
LFT422DL	22	165-240	G13	Daylight	6500	2150	320°	26	1212	1198	A+	1
LFT524WW	24	165-240	G13	Warm White	3000	2300	320°	26	1513	1500	A+	1
LFT524CW	24	165-240	G13	Cool White	4000	2500	320°	26	1513	1500	A+	1
LFT524DL	24	165-240	G13	Daylight	6500	2550	320°	26	1513	1500	A+	1
LFT628CW	28	165-240	G13	Cool White	4000	2900	320°	28	1780	1763	A+	1
LFT628DL	28	165-240	G13	Daylight	6500	3000	320°	28	1780	1763	A+	1

* See website for fitting instructions.

Crompton Lamps recommends wiring directly to mains for optimum efficiency.

* 6ft LED T8 Tubes have a 25,000 hour life cycle, 12,500 switching cycles & 4 year warranty.



View on Youtube

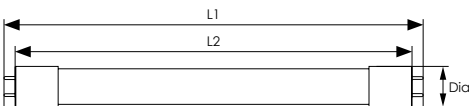

G13 Cap





LED T8 Full Glass Tube with Foodsafe Shatterproof Coating



We now provide a range of full glass tube coatings for fragment retention. Our foodsafe coating, which is IEC 61549 compliant and can also be used for long life lamps is recognisable by a green band.

Crompton shatterproof tubes are full glass tubes coated in a special material with the sole purpose of fragment retention. A glass tube breakage can put a costly stop to production, as well as obvious health risks that glass fragments can create. A common misconception is that the glass tube itself is shatterproof, when in fact it is the sleeve acting as an aid to glass retention. The material is either extruded or heat shrunk to a lamp, acting as a glass collector should the lamp itself shatter.



Product Code	Watts (W)	Volts (V)	Cap	Colour Appearance	Colour Temp (K)	Total Lumens (lm)	Beam Angle	Dimensions (mm)			Energy Rating	Order Qty
								Dia	L1	L2		
Foodsafe Shatterproof - Single Carton												
LFT29WW-SF	9	165-240	G13	Warm White	3000	800	320°	26	602	588	A+	36
LFT29CW-SF	9	165-240	G13	Cool White	4000	810	320°	26	602	588	A+	36
LFT29DL-SF	9	165-240	G13	Daylight	6500	900	320°	26	602	588	A+	36
LFT314WW-SF	14	165-240	G13	Warm White	3000	1100	320°	26	906	894	A+	36
LFT314CW-SF	14	165-240	G13	Cool White	4000	1200	320°	26	906	894	A+	36
LFT314DL-SF	14	165-240	G13	Daylight	6500	1300	320°	26	906	894	A+	36
LFT422WW-SF	22	165-240	G13	Warm White	3000	1950	320°	26	1212	1198	A+	36
LFT422CW-SF	22	165-240	G13	Cool White	4000	2050	320°	26	1212	1198	A+	36
LFT422DL-SF	22	165-240	G13	Daylight	6500	2150	320°	26	1212	1198	A+	36
LFT524WW-SF	24	165-240	G13	Warm White	3000	2300	320°	26	1513	1500	A+	36
LFT524CW-SF	24	165-240	G13	Cool White	4000	2500	320°	26	1513	1500	A+	36
LFT524DL-SF	24	165-240	G13	Daylight	6500	2550	320°	26	1513	1500	A+	36
LFT628CW-SF	28	165-240	G13	Cool White	4000	2900	320°	28	1780	1763	A+	20
LFT628DL-SF	28	165-240	G13	Daylight	6500	3000	320°	28	1780	1763	A+	20

* See website for fitting instructions.

Crompton Lamps recommends wiring directly to mains for optimum efficiency. N.B. Item is non-returnable

* 6ft LED T8 Tubes have a 25,000 hour life cycle, 12,500 switching cycles & 4 year warranty.

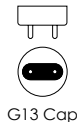
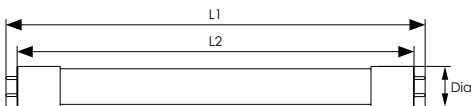



LED T5 Retrofit Full Glass Tube



88

LED T5 full glass tube with external diffused sleeve providing 270° light output. Energy saving with low power consumption. Direct retrofit into existing luminaires with no rewiring required*. Instant full light.

- 40,000 hour life, 15,000 switching cycles
- 3000K Warm White or 4000K cool white
- Standard 2ft, 3ft, 4ft or 5ft T5 lengths
- Colour rendering index Ra≥82
- Ambient operating temperature -20°C to 50°C
- No mercury or hazardous materials
- No warping, no bending
- No discolouration of light over life of tube
- Not suitable for dimming
- Not suitable for high-output fixtures
- Not suitable for emergency circuits
- Recommended for indoor use only
- Supplied in a rigid 2mm cardboard tube to minimise transportation damage

Product Code	Watts (W)	Cap	Colour Appearance	Colour Temp (K)	Total Lumens (lm)	Beam Angle	Compatible Ballast** (W)	Dimensions (mm)			Energy Rating	Order Qty
								Dia	L1	L2		
Single Carton												
9752	8	G5	Warm White	3000	760	270°	14	16	563	549	A+	1
5570	8	G5	Cool White	4000	780	270°	14	16	563	549	A+	1
9769	12	G5	Warm White	3000	1100	270°	21	16	863	849	A+	1
5587	12	G5	Cool White	4000	1100	270°	21	16	863	849	A+	1
9776	16	G5	Warm White	3000	1500	270°	28	16	1163	1149	A+	1
9783	20	G5	Warm White	3000	2300	270°	35	16	1463	1449	A+	1

*See website for fitting instructions.

** See website for list of compatible electronic ballasts. The performance of this lamp is determined by the fitting to which it is installed.

N.B. Item is non-returnable

Crompton LED T5 Full Glass Tube cannot be wired direct, lamp design requires ballast to operate

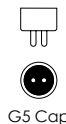
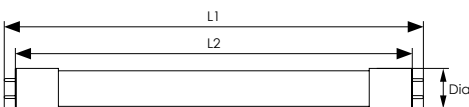



LED T5 Direct to Mains Full Glass Tube



LED T5 full glass tube with external diffused sleeve providing 270° light output. Energy saving with low power consumption. Direct to mains for maximum efficiency no ballast required*. Instant full light.

- 40,000 hour life
- 15,000 switching cycles
- 4000K cool white
- Available in 2ft, 3ft, 4ft or 5ft T5 lengths
- Colour rendering index Ra≥80
- Ambient operating temperature -20°C to 50°C
- No mercury no warping, no bending
- No discolouration of light over life of tube
- Not suitable for dimming
- Not suitable for emergency circuits
- Recommended for indoor use only
- Supplied in a rigid 2mm cardboard tube to minimise transportation damage



Product Code	Watts (W)	Volts (V)	Cap	Colour Appearance	Colour Temp (K)	Total Lumens (lm)	Beam Angle	Dimensions (mm)			Energy Rating	Order Qty
								Dia	L1	L2		
Single Carton												
12080	8	240	G5	Cool White	4000	780	270°	16	563	549	A+	1
12097	12	240	G5	Cool White	4000	1100	270°	16	863	849	A+	1
12066	16	240	G5	Cool White	4000	1580	270°	16	1163	1149	A+	1
12073	20	240	G5	Cool White	4000	2400	270°	16	1463	1449	A+	1

* Direct to mains only. Do not run with a ballast, re-wiring by a qualified person may be required, see website for instructions.

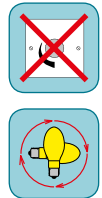
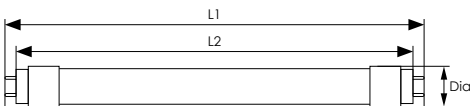



Linear



Linear halogen lamps offer excellent lumen maintenance, instant illumination and high colour rendition and are widely used in display lighting, up-lighters and floodlights.



- 2,000 hour life
- Energy saving
- R7s cap
- Clear finish
- Dimmable
- UV stop glass
- 240V or 110V options
- Internally fused for safety

90

Product Code	Watts (W)	Volts (V)	Cap	Colour Appearance	Colour Temp (K)	Total Lumens (lm)	Halogen Equivalent (W)	Dimensions (mm)		Energy Rating	Order Qty
								Dia	L		
Single Carton											
ETH48R7	48	240	R7s	Warm White	2700	745	60	12	78		10
ETH80R7	80	240	R7s	Warm White	2700	1400	100	12	78		10
ETH80R7L	80	240	R7s	Warm White	2700	1400	100	12	117		10
ETH120R7S	120	240	R7s	Warm White	2700	2250	150	12	78		10
ETH120R7L	120	240	R7s	Warm White	2700	2250	150	12	117		10
ETH160R7	160	240	R7s	Warm White	2700	3100	200	12	117		10
ETH230R7	230	240	R7s	Warm White	2700	4650	300	12	117		10
ETH230R7110	230	110	R7s	Warm White	2700	4650	300	12	117		10
ETH400R7	400	240	R7s	Warm White	2700	8550	500	12	117		10
ETH400R7110	400	110	R7s	Warm White	2700	8550	500	12	117		10

See page 126 for important circuit information.

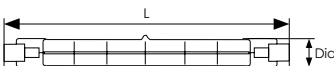

R7s Cap

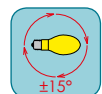

ENERGY SAVING HALOGEN

G9 Capsule



Halogen capsule lamps are used in display and accent light fixtures providing an extremely compact light source. They are made from UV stop glass, removing the need for additional UV protection.

- 2,000 hour life
- Energy saving
- G9 cap
- Clear finish
- Dimmable
- UV stop glass
- Internally fused for safety



91

Product Code	Watts (W)	Volts (V)	Cap	Colour Appearance	Colour Temp (K)	Total Lumens (lm)	Incandescent Equivalent (W)	Dimensions (mm)		Energy Rating	Order Qty
								Dia	H		
Single Carton											
ETHG918C	18	240	G9	Warm White	2700	205	24	14	40		10
ETHG933C	33	240	G9	Warm White	2700	460	43	14	40		10
ETHG942C	42	240	G9	Warm White	2700	630	55	14	40		10

See page 126 for important circuit information.

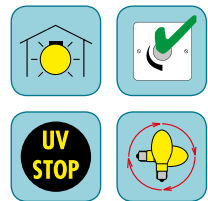
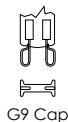
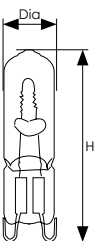



LED AR111 Direct Retrofit

- 12.5W energy saving LED with low power consumption
- Equivalent to 100W Halogen AR111
- Direct retrofit into most existing 12V AC/DC transformers
- 3000K warm white or 4000K cool white colour temperature
- Ideal for display lighting in bars, restaurants, hotels and retail

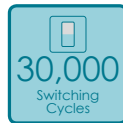
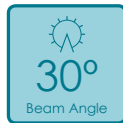

View our full range of innovative LED Products

 www.cromptonlamps.com



T2 ultra mini spiral rapid start energy efficient lamp for use in a multitude of interior and exterior luminaires (suitably IP rated) with a choice of wattage and cap type.

- 10,000 hour life
- Rapid start
- Self ballasted
- Last up to 10 times longer than a standard GLS
- SPECTRA-PLUS Triphosphor coated for excellent colour rendering, high output and longer life
- 2700K warm white colour
- BC-B22d, ES-E27 or SES-E14 cap
- Not suitable for dimming or electronic switching
- Internally fused for safety



Product Code	Watts (W)	Volts (V)	Cap	Colour Appearance	Colour Temp (K)	Total Lumens (lm)	Incan. Equiv. (W)	Dimensions (mm)		Energy Rating	Order Qty
								Dia	H		
Single Carton											
BPCFT211WWBC-1BL	11	240	BC-B22d	Warm White	2700	650	54	42	96	A	10
BPCFT211WWES-1BL	11	240	ES-E27	Warm White	2700	650	54	42	96	A	10
BPCFT211WSES-1BL	11	240	SES-E14	Warm White	2700	650	54	42	98	A	10
BPCFT215WWBC-1BL	15	240	BC-B22d	Warm White	2700	850	67	42	105	A	10
BPCFT215WWES-1BL	15	240	ES-E27	Warm White	2700	850	67	42	105	A	10
BPCFT220WWBC-1BL	20	240	BC-B22d	Warm White	2700	1200	88	53	117	A	10
BPCFT220WWES-1BL	20	240	ES-E27	Warm White	2700	1200	88	53	120	A	10
BPCFT223WWBC-1BL	23	240	BC-B22d	Warm White	2700	1600	112	53	121	A	10

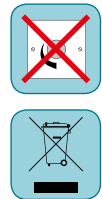
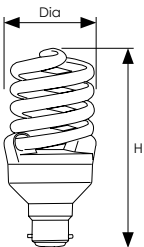



T4 Stick Lamp



Compact fluorescent lamps are commonly for use in a multitude of luminaires.

- 10,000 hour life
- 2700K warm white
- RA≥82 colour rendering index
- SPECTRA-PLUS Triphosphor coated for excellent colour rendering, high output and longer life
- Not suitable for dimming
- Complete with integral starter
- Internally fused for safety

Product Code	Watts (W)	Volts (V)	Cap	Colour Appearance	Colour Temp (K)	Total Lumens (lm)	Dimensions (mm)		Energy Rating	Order Qty
							Dia	H		
Single Carton										
4023	11	240	BC-B22d	Warm White	2700	670	40	149	A	10

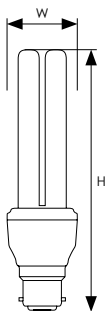

BC-B22d Cap





Single Turn S Type (PL) 2 Pin



Compact S fluorescent lamps are commonly used in commercial and domestic luminaires such as downlights, bulkheads and other suitable applications.

- 10,000 hour life
- 3000K warm white, 3500K white or 4000K cool white colour options
- 85/1B colour rendering index/group
- SPECTRA-PLUS Triphosphor coated for excellent colour rendering, high output and longer life
- Separate ballast/control gear required
- Not suitable for dimming



Product Code	Watts (W)	Cap	Colour Appearance	Colour Temp (K)	Total Lumens (lm)	Dimensions (mm)		Energy Rating	Order Qty
						W	L		
Single Carton									
CLS5SWW	5	G23 2 Pin	Warm White	3000	265	32	105	B	10
CLS5SW	5	G23 2 Pin	White	3500	265	32	105	B	10
CLS5SCW	5	G23 2 Pin	Cool White	4000	265	32	105	B	10
CLS7SWW	7	G23 2 Pin	Warm White	3000	400	32	135	B	10
CLS7SW	7	G23 2 Pin	White	3500	400	32	135	B	10
CLS7SCW	7	G23 2 Pin	Cool White	4000	400	32	135	B	10
CLS9SWW	9	G23 2 Pin	Warm White	3000	600	32	164	A	10
CLS9SW	9	G23 2 Pin	White	3500	605	32	164	A	10
CLS9SCW	9	G23 2 Pin	Cool White	4000	600	32	164	A	10
CLS11SWW	11	G23 2 Pin	Warm White	3000	905	32	233	A	10
CLS11SW	11	G23 2 Pin	White	3500	905	32	233	A	10
CLS11SCW	11	G23 2 Pin	Cool White	4000	905	32	233	A	10



G23 2 Pin Cap





Single Turn S Type (PL) 4 Pin



Compact S fluorescent lamps are commonly used in commercial and domestic luminaires such as downlights, bulkheads and other suitable applications.

- 10,000 hour life
- 4000K cool white
- 85/1B colour rendering index/group
- SPECTRA-PLUS Triphosphor coated for excellent colour rendering, high output and longer life
- Separate ballast/control gear required
- Suitable for dimming and use in emergency luminaires

Product Code	Watts (W)	Cap	Colour Appearance	Colour Temp (K)	Total Lumens (lm)	Dimensions (mm)		Energy Rating	Order Qty
						W	L		
Single Carton									
CLSE5SCW	5	2G7 4 Pin	Cool White	4000	240	37	88	A	10
CLSE7SCW	7	2G7 4 Pin	Cool White	4000	400	37	120	A	10
CLSE9SCW	9	2G7 4 Pin	Cool White	4000	605	37	149	A	10
CLSE11SCW	11	2G7 4 Pin	Cool White	4000	905	37	218	A	10

96

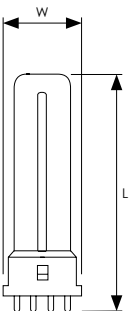

2G7 4 Pin Cap





Single Turn L Type (PLL)



Compact L fluorescent lamps for commercial luminaires such as downlights, bulkheads and many other applications.

- 10,000 hour life
- 3500K white, 4000K cool white or 6500K daylight colour options
- 85/1B colour rendering index/group
- SPECTRA-PLUS Triphosphor coated for excellent colour rendering, high output and longer life
- Suitable for dimming and use in emergency luminaires
- Separate ballast/control gear required
- Internally fused for safety

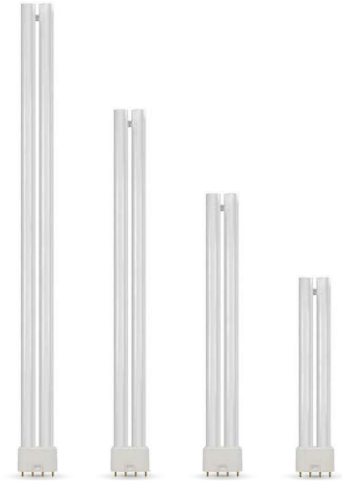

Product Code	Watts (W)	Cap	Colour Appearance	Colour Temp (K)	Total Lumens (lm)	Dimensions (mm)		Energy Rating	Order Qty
						W	L		
Single Carton									
CLL18SW	18	2G11	White	3500	1206	44	226	A	10
CLL18SCW	18	2G11	Cool White	4000	1206	44	226	A	10
CLL24SW	24	2G11	White	3500	1800	44	321	A	10
CLL24SCW	24	2G11	Cool White	4000	1800	44	321	A	10
CLL36SW	36	2G11	White	3500	2920	44	416	A	10
CLL36SCW	36	2G11	Cool White	4000	2920	44	416	A	10
CLL40SW	40	2G11	White	3500	3320	44	536	A	10
CLL40SCW	40	2G11	Cool White	4000	3320	44	536	A	10
CLL55SW	55	2G11	White	3500	4510	44	536	A	10
CLL55SCW	55	2G11	Cool White	4000	4510	44	536	A	10
CLL55SDYLT	55	2G11	Day Light	6500	4510	44	536	A	10

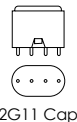
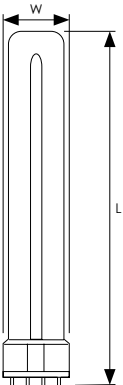



Double Turn D Type (PLC)



Compact D fluorescent lamps are commonly used in commercial and domestic luminaires such as downlights, bulkheads, pendants and other suitable energy saving applications.

- 10,000 hour life
- 3000K warm white, 3500K white or 4000K cool white colour options
- 85/1B colour rendering index/group
- SPECTRA-PLUS Triphosphor coated for excellent colour rendering, high output and longer life
- Not suitable for dimming
- Complete with integral starter
- Internally fused for safety

Product Code	Watts (W)	Cap	Colour Appearance	Colour Temp (K)	Total Lumens (lm)	Dimensions (mm)		Energy Rating	Order Qty
						W	L		
Single Carton									
CLD10SWW	10	G24d-1 2 Pin	Warm White	3000	600	41	110	B	10
CLD10SW	10	G24d-1 2 Pin	White	3500	600	41	110	B	10
CLD10SCW	10	G24d-1 2 Pin	Cool White	4000	600	41	110	B	10
CLD13SWW	13	G24d-1 2 Pin	Warm White	3000	900	41	138	A	10
CLD13SW	13	G24d-1 2 Pin	White	3500	900	41	138	A	10
CLD13SCW	13	G24d-1 2 Pin	Cool White	4000	900	41	138	A	10
CLD18SWW	18	G24d-2 2 Pin	Warm White	3000	1210	41	153	B	10
CLD18SW	18	G24d-2 2 Pin	White	3500	1210	41	153	B	10
CLD18SCW	18	G24d-2 2 Pin	Cool White	4000	1210	41	153	B	10
CLD26SWW	26	G24d-3 2 Pin	Warm White	3000	1716	41	172	A	10
CLD26SW	26	G24d-3 2 Pin	White	3500	1716	41	172	A	10
CLD26SCW	26	G24d-3 2 Pin	Cool White	4000	1716	41	172	A	10



G24d-1 2 Pin Cap



G24d-2 2 Pin Cap



G24d-3 2 Pin Cap





Double Turn DE Type (PLC-E)



Compact DE fluorescent lamps are used in commercial and domestic luminaires such as downlights, bulkheads, pendants and other suitable applications.

- 10,000 hour life
- 3000K warm white, 3500K white or 4000K cool white colour options
- 85/1B colour rendering index/group
- SPECTRA-PLUS Triphosphor coated for excellent colour rendering, high output and longer life
- Suitable for dimming and use in emergency luminaires
- To be used with external starter or electronic ballast



Product Code	Watts (W)	Cap	Colour Appearance	Colour Temp (K)	Total Lumens (lm)	Dimensions (mm)		Energy Rating	Order Qty
						W	L		
Single Carton									
CLDE10SW	10	G24q-1 4 Pin	White	3500	600	41	109	A	10
CLDE10SCW	10	G24q-1 4 Pin	Cool White	4000	600	41	109	A	10
CLDE13SWW	13	G24q-1 4 Pin	Warm White	3000	900	41	131	A	10
CLDE13SW	13	G24q-1 4 Pin	White	3500	900	41	131	A	10
CLDE13SCW	13	G24q-1 4 Pin	Cool White	4000	900	41	131	A	10
CLDE18SWW	18	G24q-2 4 Pin	Warm White	3000	1210	41	146	A	10
CLDE18SW	18	G24q-2 4 Pin	White	3500	1210	41	146	A	10
CLDE18SCW	18	G24q-2 4 Pin	Cool White	4000	1210	41	146	A	10
CLDE26SWW	26	G24q-3 4 Pin	Warm White	3000	1716	41	165	A	10
CLDE26SW	26	G24q-3 4 Pin	White	3500	1716	41	165	A	10
CLDE26SCW	26	G24q-3 4 Pin	Cool White	4000	1716	41	165	A	10

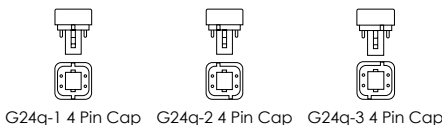



Triple Turn TE Type (PLT)



Compact TE fluorescent lamps used in commercial luminaires such as downlights, bulkheads, pendants and many other applications.



- 10,000 hour life
- 3500K white or 4000K cool white colour options
- 85/1B colour rendering index/group
- SPECTRA-PLUS Triphosphor coated for excellent colour rendering, high output and longer life
- Suitable for use in emergency luminaires
- Not suitable for dimming
- To be used with external starter or electronic ballast
- Internally fused for safety

Product Code	Watts (W)	Cap	Colour Appearance	Colour Temp (K)	Total Lumens (lm)	Dimensions (mm)		Energy Rating	Order Qty
						W	L		
Single Carton									
CLTE13SCW	13	Gx24q-1 4 Pin	Cool White	4000	900	49	103	A	10
CLTE18SW	18	Gx24q-2 4 Pin	White	3500	1210	49	118	A	10
CLTE18SCW	18	Gx24q-2 4 Pin	Cool White	4000	1210	49	118	A	10
CLTE26SW	26	Gx24q-3 4 Pin	White	3500	1800	49	139	A	10
CLTE26SCW	26	Gx24q-3 4 Pin	Cool White	4000	1800	49	139	A	10
CLTE32SW	32	Gx24q-3 4 Pin	White	3500	2000	49	139	A	10
CLTE32SCW	32	Gx24q-3 4 Pin	Cool White	4000	2000	49	139	A	10
CLTE42SW	42	Gx24q-4 4 Pin	White	3500	2700	49	165	A	10
CLTE42SCW	42	Gx24q-4 4 Pin	Cool White	4000	2700	49	165	A	10

100

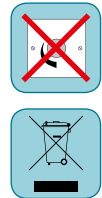
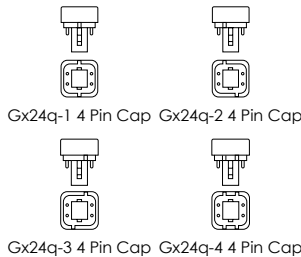
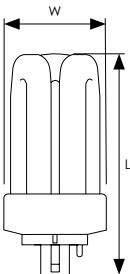

CFL COMPACT FLUORESCENT

CC



Energy efficient compact fluorescent lamp widely used with slim profile decorative and tough exterior luminaires.

- 10,000 hour life
- 2700K warm white, 3500K white or 4000K cool white colour options
- 82/1B colour rendering index/group
- 2 or 4 pin cap
- Separate ballast/control gear required
- 2 pin lamps are not suitable for dimming
- 4 pin lamps are suitable for dimming and suitable for use in emergency luminaires
- Internally fused for safety



Product Code	Watts (W)	Cap	Colour Appearance	Colour Temp (K)	Total Lumens (lm)	Dimensions (mm)		Energy Rating	Order Qty
						W	H		
Single Carton									
CLC16WW2PIN	16	GR8 2 pin	Warm White	2700	1100	135	135	A	20
CLC16W2PIN	16	GR8 2 pin	White	3500	1100	135	135	A	20
CLC16CW2PIN	16	GR8 2 pin	Cool White	4000	1100	135	135	A	20
CLC16WW4PIN	16	GR10q 4 pin	Warm White	2700	1100	135	135	A	20
CLC16W4PIN	16	GR10q 4 pin	White	3500	1100	135	135	A	20
CLC16CW4PIN	16	GR10q 4 pin	Cool White	4000	1100	135	135	A	20
CLC28WW2PIN	28	GR8 2 pin	Warm White	2700	2050	195	200	A	20
CLC28W2PIN	28	GR8 2 pin	White	3500	2050	195	200	A	20
CLC28CW2PIN	28	GR8 2 pin	Cool White	4000	2050	195	200	A	20
CLC28WW4PIN	28	GR10q 4 pin	Warm White	2700	2050	195	200	A	20
CLC28W4PIN	28	GR10q 4 pin	White	3500	2050	195	200	A	20
CLC28CW4PIN	28	GR10q 4 pin	Cool White	4000	2050	195	200	A	20
CLC38WW4PIN	38	GR10q 4 pin	Warm White	2700	2700	195	200	A	20
CLC38W4PIN	38	GR10q 4 pin	White	3500	2700	195	200	A	20
CLC38CW4PIN	38	GR10q 4 pin	Cool White	4000	2700	195	200	A	20

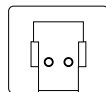
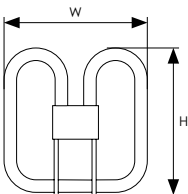

GR8 2 Pin Cap

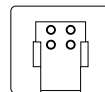

GR10q 4 Pin Cap

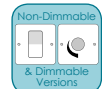



T5 Halophosphate



T5 linear fluorescent tubes in lower wattages for use in emergency luminaires, furniture fixtures, pelmet lighting and display cabinets.

- 5,000 hour life
- WATTS AVER Halophosphate
- 3000K warm white, 3500K white or 4000K cool white colour options
- Energy efficient and value for money



Product Code	Watts (W)	Cap	Colour Appearance	Colour Temp (K)	Total Lumens (lm)	Colour Rendering Index/Group	Dimensions (mm)			Energy Rating	Order Qty
							Dia	L1	L2		
Single Sleeve											
FT96W	6	G5	White	3500	260	54/3	16	212	226	B	25
FT96CW	6	G5	Cool White	4000	260	58/3	16	212	226	B	25
FT128WW	8	G5	Warm White	3000	380	51/3	16	288	300	B	25
FT128W	8	G5	White	3500	380	54/3	16	288	300	B	25
FT128CW	8	G5	Cool White	4000	380	58/3	16	288	300	B	25
FT2113W	13	G5	White	3500	800	54/3	16	517	530	A	25
FT2113CW	13	G5	Cool White	4000	800	58/3	16	517	530	A	25

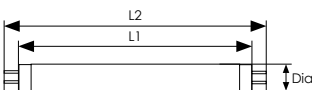

G5 Cap





T5 Triphosphor



At only 16mm diameter, the T5 linear fluorescent range is used in slim luminaires and fixtures and is available in High Efficiency (HE) for maximum energy saving or High Output (HO) for maximum lumen output.

- 20,000 hour life
- 85/1B colour rendering index/group
- SPECTRA-PLUS Triphosphor
- 3500K white, 4000K cool white or 6500K daylight colour options
- Excellent colour rendering and high lumen maintenance
- Designed for use with High Frequency ballasts



Product Code	Watts (W)	Cap	Colour Appearance	Colour Temp (K)	Total Lumens (lm)	Colour Rendering Index/Group	Dimensions (mm)			Energy Rating	Order Qty
							Dia	L1	L2		
High Efficiency (HE) - Single Sleeve											
FTT514SPW	14	G5	White	3500	1205	85/1B	16	549	562	A	30
FTT514SPCW	14	G5	Cool White	4000	1205	85/1B	16	549	562	A	30
FTT514SPDYLT	14	G5	Daylight	6500	1100	85/1B	16	549	562	A	30
FTT521SPW	21	G5	White	3500	1900	85/1B	16	849	862	A+	30
FTT521SPCW	21	G5	Cool White	4000	1900	85/1B	16	849	862	A+	30
FTT528SPW	28	G5	White	3500	2605	85/1B	16	1149	1162	A+	30
FTT528SPCW	28	G5	Cool White	4000	2605	85/1B	16	1149	1162	A+	30
FTT528SPDYLT	28	G5	Daylight	6500	2400	85/1B	16	1149	1162	A	30
FTT535SPW	35	G5	White	3500	3300	85/1B	16	1449	1462	A+	30
FTT535SPCW	35	G5	Cool White	4000	3300	85/1B	16	1449	1462	A+	30
FTT535SPDYLT	35	G5	Daylight	6500	3050	85/1B	16	1449	1462	A	30
High Output (HO) - Single Sleeve											
FTT524SPCW	24	G5	Cool White	4000	1755	85/1B	16	549	562	A	30
FTT524SPDYLT	24	G5	Daylight	6500	1600	85/1B	16	549	562	A	30
FTT539SPCW	39	G5	Cool White	4000	3100	85/1B	16	849	862	A	30
FTT554SPCW	54	G5	Cool White	4000	4450	85/1B	16	1149	1162	A	30
FTT549SPCW	49	G5	Cool White	4000	4315	85/1B	16	1449	1462	A	30
FTT549SPDYLT	49	G5	Daylight	6500	3950	85/1B	16	1449	1462	A	30
FTT580SPCW	80	G5	Cool White	4000	6160	85/1B	16	1449	1462	A	30

See page 88 for LED alternative

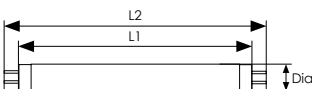

G5 Cap





T8 Triphosphor

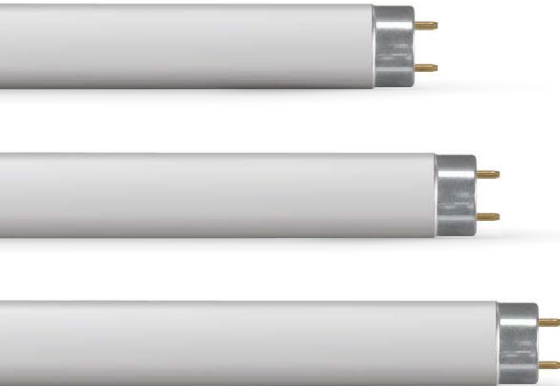

A comprehensive range of 26mm diameter Triphosphor fluorescent tubes providing excellent colour rendering, high output and extended life.

- 15,000 hour life
- SPECTRA-PLUS Triphosphor
- 3000K warm white, 3500K white, 4000K cool white or 6500K daylight colour options
- Excellent colour rendering and high lumen maintenance

104

Product Code	Watts (W)	Cap	Colour Appearance	Colour Temp (K)	Total Lumens (lm)	Colour Rendering Index/Group	Dimensions (mm)			Energy Rating	Order Qty
							Dia	L1	L2		
Single Sleeve											
FT1815SPW	15	G13	White	3500	960	85/1B	26	438	450	B	25
FT1815SPCW	15	G13	Cool White	4000	960	85/1B	26	438	450	B	25
FT1815SPDYLT	15	G13	Daylight	6500	900	85/1B	26	438	450	B	25
FT218SPWW	18	G13	Warm White	3000	1350	85/1B	26	590	604	A	25
FT218SPW	18	G13	White	3500	1350	85/1B	26	590	604	A	25
FT218PCW	18	G13	Cool White	4000	1350	85/1B	26	590	604	A	25
FT218SPDYLT	18	G13	Daylight	6500	1350	85/1B	26	590	604	A	25
FT330SPW	30	G13	White	3500	2400	85/1B	26	895	910	A	25
FT330PCW	30	G13	Cool White	4000	2400	85/1B	26	895	910	A	25
FT330SPDYLT	30	G13	Daylight	6500	2200	85/1B	26	895	910	A	25
FT436SPWW	36	G13	Warm White	3000	3350	85/1B	26	1200	1212	A	25
FT436SPW	36	G13	White	3500	3350	85/1B	26	1200	1212	A	25
FT436PCW	36	G13	Cool White	4000	3350	85/1B	26	1200	1212	A	25
FT436SPDYLT	36	G13	Daylight	6500	3350	85/1B	26	1200	1212	A	25
FT558SPWW	58	G13	Warm White	3000	5200	85/1B	26	1500	1510	A	25
FT558SPW	58	G13	White	3500	5200	85/1B	26	1500	1510	A	25
FT558PCW	58	G13	Cool White	4000	5200	85/1B	26	1500	1510	A	25
FT558SPDYLT	58	G13	Daylight	6500	5000	85/1B	26	1500	1510	A	25
FT670SPW	70	G13	White	3500	6300	85/1B	26	1763	1775	A	25
FT670SPCW	70	G13	Cool White	4000	6300	85/1B	26	1763	1775	A	25
FT670SPDYLT	70	G13	Daylight	6500	5800	85/1B	26	1763	1775	A	25

See Page 86 for LED alternative

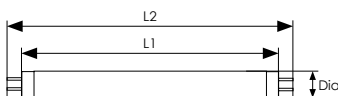

G13 Cap





T9 Circular Triphosphor



Circular Triphosphor fluorescent tubes with 29mm tube diameter for use with decorative luminaires, offering energy efficiency and value for money.

- 10,000 hour life
- SPECTRA-PLUS Triphosphor
- Excellent colour rendering and high lumen maintenance
- 3000K warm white or 4000K cool white colour options



Product Code	Watts (W)	Cap	Colour Appearance	Colour Temp (K)	Total Lumens (lm)	Colour Rendering Index/Group	Dimensions (mm)		Energy Rating	Order Qty
							Dia	O/A		
Single Carton										
CIR22SPWW	22	G10q 4 pin	Warm White	3000	1200	81/1B	29	210	B	12
CIR22SPCW	22	G10q 4 pin	Cool White	4000	1200	81/1B	29	210	B	12
CIR32SPWW	32	G10q 4 pin	Warm White	3000	2300	81/1B	29	300	A	12
CIR32SPCW	32	G10q 4 pin	Cool White	4000	2300	81/1B	29	300	A	12
CIR40SPWW	40	G10q 4 pin	Warm White	3000	3150	81/1B	29	400	A	12
CIR40SPCW	40	G10q 4 pin	Cool White	4000	3150	81/1B	29	400	A	12
CIR60SPWW	60	G10q 4 pin	Warm White	3000	4300	81/1B	29	400	A	12
CIR60SPCW	60	G10q 4 pin	Cool White	4000	4300	81/1B	29	400	A	12

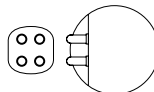
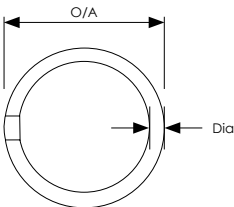

G10q 4 Pin Cap





Starter Switches



Glowstarters for fluorescent lamps, available for use with a variety of lamp wattages.



- Starters for 4W to 65W fluorescent lamps
- Starters for 70W to 125W fluorescent lamps
- Series starters for 4W to 22W fluorescent lamps
- Polycarbonate UV stable canister
- Ambient temperature range 0-55°C

Product Code	Lamp Range (W)	Mains Voltage Range (V)	Pin Centres (mm)	Dimensions (mm)		Order Qty
				Dia	H	
Starter - Single Carton						
FSU-10	4-65	220V-240V	12.7	21	39	10
FS125	70-125	220V-240V	12.7	21	39	10
Series Starter - Single Carton						
FS2	4-22	110-130V / 220V-240V	12.7	21	39	10

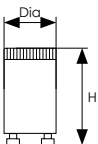



Ceramic Metal Halide



Ceramic metal halide lamps cater for the retail industry with their excellent colour stability through life and high efficacy.

- UV stop glass
- 3000K warm white or 4200K cool white colour options
- Ceramic metal halide options
- Metal halide lamps require enclosure with cover glass
- G8.5 or G12 cap
- Ignitor required



Product Code	Watts (W)	Operating Position	Cap	Colour Rendering Index/Group	Colour Temp (K)	Circuit Type	Total Lumens (lm)	Average Rated Life (hrs)	Energy Rating	Order Qty
Single Carton										
MHTCER70WG8.53K	70	Univ	G8.5	80/1B	3000	SON	6400	15000	A+	12
MHTCER150WG124K	150	Univ	G12	90/1B	4200	SON	13000	12000	A	12

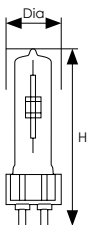

Watts (W)	Dimensions (mm)	
	Dia	H
35	15	90
70	19	90
150	19	100

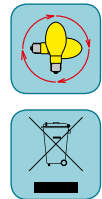
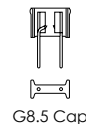
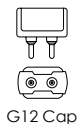



Double Ended Metal Halide



Double ended metal halide lamps are compact in size and shape making them ideal for downlights and small floodlights.

- UV stop glass
- 3000K warm white or 4200K cool white colour options
- Ceramic metal halide options
- Metal halide lamps require enclosure with cover glass
- RX7s cap
- Ignitor required

Product Code	Watts (W)	Operating Position	Cap	Colour Rendering Index/Group	Colour Temp (K)	Circuit Type	Total Lumens (lm)	Average Rated Life (hrs)	Energy Rating	Order Qty
Single Carton										
MHOTS70N	70	Hor±45°	RX7s	70/1B	4200	SON	6300	10000	A+	25
MHOTS70W	70	Hor±45°	RX7s	70/1B	3000	SON	6400	10000	A+	25
MHOTS150N	150	Hor±45°	RX7s	70/1B	4200	SON	14000	10000	A+	25
MHOTS150W	150	Hor±45°	RX7s	70/1B	3000	SON	14000	10000	A+	25

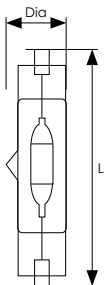

Watts (W)	Dimensions (mm)	
	Dia	L
70	20	114
150	20	132



RX7s Cap

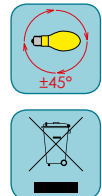



Elliptical Metal Halide for Open Luminaires



Metal halide lamps give a white light and have high colour rendering ability. Elliptical coated lamps give less glare and are more suited to industrial area lighting.

- Up to 20,000 hour life
- UV stop glass
- ES-E27 or GES-E40 cap



Product Code	Watts (W)	Operating Position	Cap	Colour Rendering Index/Group	Colour Temp (K)	Circuit Type	Total Lumens (lm)	Average Rated Life (hrs)	Energy Rating	Order Qty
Single Carton										
MHE70WESHP SOP4K	70	Univ	ES-E27	70/2A	3700	SON	6300	15000	A+	12
MHE400WGESHP SOP4K	400	V±15°	GES-E40	70/2A	3700	SON	41900	20000	A+	6

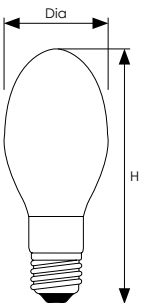

Watts (W)	Dimensions (mm)	
	Dia	H
70	54	141
400	120	296

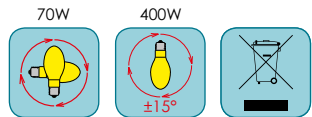



Metal Halide for Enclosed Luminaires



Metal halide lamps give a white light and have high colour rendering ability. Tubular clear lamps are most commonly used in floodlighting applications.

- Up to 15,000 hour life
- Metal halide lamps require enclosure with cover glass
- GES-E40 or ES-E27 cap

Product Code	Watts (W)	Operating Position	Cap	Colour Rendering Index/Group	Colour Temp (K)	Circuit Type	Total Lumens (lm)	Average Rated Life (hrs)	Energy Rating	Order Qty
--------------	-----------	--------------------	-----	------------------------------	-----------------	--------------	-------------------	--------------------------	---------------	-----------

Single Carton

MHT70WESHPSN4K	70	Univ	ES-E27	68/2A	4000	SON	6500	15000	A+	12
MHT150WESHPSN4K	150	Univ	ES-E27	68/2B	4000	SON	15400	15000	A+	12
MHT250WGESHPSEN4K	250	Univ	GES-E40	68/2B	4000	SON	21400	10000	A+	12
MHT250WGESMER4K	250	Univ	GES-E40	68/2B	4000	Mercury	25200	10000	A+	12
MHT400WGESMER4K	400	Univ	GES-E40	68/2B	4000	Mercury	46100	15000	A+	12

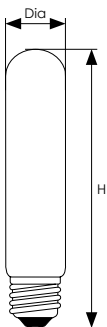

Watts (W)	Dimensions (mm)	
	Dia	H
Tubular Clear		
70	38	156
150	38	156
250	46	256
400	46	285



GES-E40 Cap



ES-E27 Cap

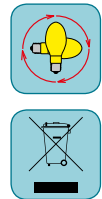



Dual Metal Halide for Enclosed Luminaires



Dual metal halide lamps give a white light and have high colour rendering ability. Tubular clear lamps are more commonly used in floodlighting applications, where as elliptical coated lamps give less glare and are more suited to industrial area lighting. These lamps are both Son and Mercury control gear compatible.

- UV stop glass
- Metal halide lamps require enclosure with cover glass
- GES-E40 cap



Product Code	Watts Operating (W)	Position	Cap	Colour Rendering Index/Group	Colour Temp (K)	Circuit Type	Total Lumens		Average Rated Life (hrs)	Energy Rating	Order Qty	
							SON	Mercury				
Elliptical Coated - Single Carton												
MHE250WGESDU4K	250	Univ	GES-E40	70/2B	4100	SON/ Mercury	24000	19000	10000	SON MER	A+ A	12
MHE400WGESDU4K	400	Univ	GES-E40	70/2A	4000	SON/ Mercury	39000	31000	20000	SON MER	A+ A	6
Tubular Clear - Single Carton												
MHT250WGESDU4K	250	Univ	GES-E40	68/2A	4100	SON/ Mercury	32000	26000	10000	SON MER	A+ A	12
MHT400WGESDU4K	400	Univ	GES-E40	68/2B	4300	SON/ Mercury	45000	35000	15000	SON MER	A+ A	12

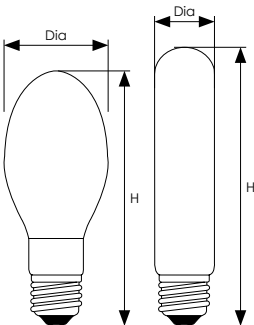

Watts (W)	Dimensions (mm)	
	Dia	H
Elliptical Coated		
250	90	215
400	118	281
Tubular Clear		
250	46	256
400	46	256

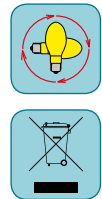



High Output HPS (SON HO) Elliptical



High output sodium lamps, usually referred to as SON HO lamps, give a golden white light and have a long life. They are suitable for use in industrial lighting, warehousing, street-lights and floodlights.



- Long life
- High output
- Universal operating position
- ES-E27 or GES-E40 cap

Product Code	Watts (W)	Operating Position	Cap	Colour Rendering Index/Group	Colour Temp (K)	Circuit Type	Total Lumens (lm)	Average Rated Life (hrs)	Energy Rating	Order Qty
Elliptical Coated - Single Carton										
SONHO70	70	Univ	ES-E27	25	2000	SON	6500	28000	A+	12
SONHO70*	70	Univ	ES-E27	25	2000	SON	5900	28000	A	12
SONHO150	150	Univ	GES-E40	25	2000	SON	16200	28000	A+	12

* Internal ignitor

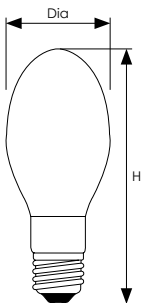

Watts (W)	Dimensions (mm)	
	Dia	H
Elliptical Coated		
250	90	215
400	118	281
Tubular Clear		
250	46	256
400	46	285

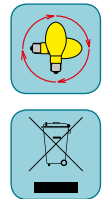



High Output HPS (SON HO) Tubular



High output sodium lamps, usually referred to as SON HO lamps, give a golden white light and have a long life. They are suitable for use in industrial lighting, warehousing, street-lights and floodlights.

- Long life
- High output
- Universal operating position
- ES-E27 or GES-E40 cap



Product Code	Watts (W)	Operating Position	Cap	Colour Rendering Index/Group	Colour Temp (K)	Circuit Type	Total Lumens (lm)	Average Rated Life (hrs)	Energy Rating	Order Qty
Tubular Clear - Single Carton										
SONTHO70	70	Univ	ES-E27	25	2000	SON	6400	28000	A+	25
SONTHO150	150	Univ	GES-E40	25	2000	SON	17200	28000	A+	12
SONTHO250	250	Univ	GES-E40	25	2000	SON	33500	28000	A+	12
SONTHO400	400	Univ	GES-E40	25	2000	SON	57000	28000	A+	12



Watts (W)	Dimensions (mm)	
	Dia	H
70	38	156
150	46	211
250	46	260
400	46	287

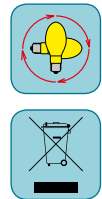



Single Ended Pulse Start Metal Halide Tubular



Metal halide lamps give a white light and have high colour rendering ability. Tubular clear lamps are more commonly used in floodlighting applications.

- Up to 20,000 hour life
- Metal halide lamps require enclosure with cover glass
- $\pm 75^\circ$ horizontal operating position
- GES-E40 cap

Product Code	Watts (W)	Operating Position	Cap	Colour Rendering Index/Group	Colour Temp (K)	Circuit Type	Total Lumens (lm)	Average Rated Life (hrs)	Energy Rating	Order Qty
Tubular Clear - Single Carton										
MHT250XPS4K	250	$\pm 75^\circ$	GES-E40	20	4500	Pulse	22000	10000	A	12
MHT400XPS4K	400	$\pm 75^\circ$	GES-E40	20	4200	Pulse	40000	20000	A+	12



Watts (W)	Dimensions (mm)	
	Dia	H
250	46	256
400	46	281



GES-E40 Cap

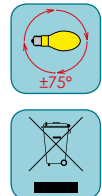

Designed for artistic activities such as painting or embroidery, the Craftlight lamp shows colours as nature intended by use of a special blue glass which absorbs the yellow part of the spectrum, giving a whiter light that closely simulates natural daylight and increasing the contrast between colours.

- 1,000 hour life
- BC-B22d or ES-E27 cap
- Dimmable
- Internally fused for safety



Product Code	Watts (W)	Volts (V)	Cap	Finish	Dimensions (mm)		Energy Rating	Order Qty
					Dia	H		
Single Carton								
CRA60BC	60	240	BC-B22d	Blue	60	103		10
CRA60ES	60	240	ES-E27	Blue	60	103		10
CRA100BC	100	240	BC-B22d	Blue	60	103		10
CRA100ES	100	240	ES-E27	Blue	60	103		10

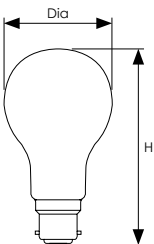



Fireglow GLS and Candle



Fireglow lamps are widely used in decorative feature fires. They are sprayed with a red fade resistant lacquer to maintain its decorative effect. For particularly hot conditions.

- 2,000 hour life
- Fade resistant Fireflame red lacquer
- Internally fused for safety

Product Code	Watts (W)	Volts (V)	Cap	Finish	Dimensions (mm)		Energy Rating	Order Qty
					Dia	H		
Fireglow Candle - Single Carton								
FIRCAN40BC	40	240	BC-B22d	Fireflame	35	90		10
FIRCAN40ES	40	240	ES-E27	Fireflame	35	90		10
FIRCAN40SES	40	240	SES-E14	Fireflame	35	90		10

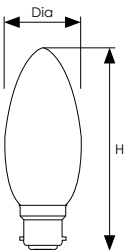

BC-B22d Cap



ES-E27 Cap



SES-E14 Cap



A range of infra red lamps harnesses the large amounts of energy radiated by incandescent reflector lamps to provide an extremely useful lamp for heating in commercial or industrial applications. A ruby coloured glass version is also available for animal husbandry uses.

- 5,000 hour long life
- Diffused, ruby or clear finish
- R125 soft or Borosilicate hard glass envelope to help resist thermal shock
- ES-E27 and BC-B22d cap
- Internally fused for safety
- Heat source lamps must be 0.5m from other objects
- Protect lamp from contact with liquids/humidity to prevent breakage due to thermal shock
- Borosilicate glass,



Product Code	Watts (W)	Volts (V)	Cap	Finish	Dimensions (mm)		Energy Rating	Order Qty
					Dia	H		
Single Carton								
IR250HGBCBC	250	240	BC-B22d	Clear	125	177		1
IR250HGDES	250	240	ES-E27	Diffused	125	177		1
IR250HGRES	250	240	ES-E27	Ruby	125	177		1

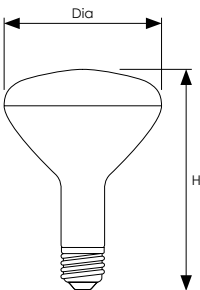



Colourglazed lamps provide strong vibrant colours as an alternative to the sparkling appearance of the Harlequin lamp. The coating is applied internally and will not wear away, which combined with the rough service vacuum construction to resist vibration, makes them ideal for outdoor applications where dirt and dust is encountered.

- 2,000 hour life
- Suitable for outdoor use
- Choice of 7 colour finishes
- BC-B22d or ES-E27 cap
- Internally fused for safety

Product Code	Watts (W)	Volts (V)	Cap	Finish	Dimensions (mm)		Energy Rating	Order Qty
					Dia	H		
Single Carton								
25ABC-GLZ	25	240	BC-B22d	Amber	60	103	E	10
25BBC-GLZ	25	240	BC-B22d	Blue	60	103	E	10
25GBC-GLZ	25	240	BC-B22d	Green	60	103	E	10
25PIBC-GLZ	25	240	BC-B22d	Pink	60	103	E	10
25RBC-GLZ	25	240	BC-B22d	Red	60	103	E	10
25WBC-GLZ	25	240	BC-B22d	White	60	103	E	10
25YBC-GLZ	25	240	BC-B22d	Yellow	60	103	E	10
25AES-GLZ	25	240	ES-E27	Amber	60	105	E	10
25BES-GLZ	25	240	ES-E27	Blue	60	105	E	10
25GES-GLZ	25	240	ES-E27	Green	60	105	E	10
25PIES-GLZ	25	240	ES-E27	Pink	60	105	E	10
25RES-GLZ	25	240	ES-E27	Red	60	105	E	10
25WES-GLZ	25	240	ES-E27	White	60	105	E	10
25YES-GLZ	25	240	ES-E27	Yellow	60	105	E	10
40YBC-GLZ	40	240	BC-B22d	Yellow	60	103	E	10
60ABC-GLZ	60	240	BC-B22d	Amber	60	103	E	10
60BBC-GLZ	60	240	BC-B22d	Blue	60	103	E	10
60PIBC-GLZ	60	240	BC-B22d	Pink	60	103	E	10

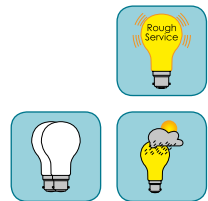
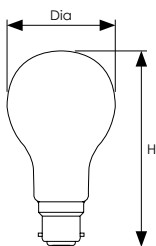

Sign lamps are vacuum filled and are of rough service construction making them ideal for external use. Sign lamps are widely used for decorative applications requiring colour and sparkle.

- 1,000 hour life
- Suitable for indoor and outdoor use
- Clear finish
- BC-B22d, SBC-B15d or SES-E14 cap
- 240V or 110V
- Internally fused for safety



Product Code	Watts (W)	Volts (V)	Cap	Finish	Dimensions (mm)		Energy Rating	Order Qty
					Dia	H		
Single Carton								
SIG15CBC	15	240	BC-B22d	Clear	28	58	E	10
SIG15CSBC	15	240	SBC-B15d	Clear	28	62	E	10
SIG15CSES	15	240	SES-E14	Clear	28	63	E	10
SIG25CBC	25	240	BC-B22d	Clear	28	58	E	10
SIG25CSBC	25	240	SBC-B15d	Clear	28	62	E	10
SIG25CSES	25	240	SES-E14	Clear	28	63	E	10

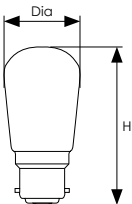



Colourglazed Sign



Colourglazed lamps provide strong vibrant colours as an alternative to the sparkling appearance of the Harlequin lamp. The coating is applied internally and will not wear away, which combined with the rough service vacuum construction to resist vibration, makes them ideal for outdoor applications where dirt and dust is encountered. Sign lamps are widely used for decorative applications requiring colour and sparkle.

- 1,000 hour life
- Suitable for indoor and outdoor use
- Choice of 7 colour finishes
- BC-B22d or SES-E14 caps
- Internally fused for safety

Product Code	Watts (W)	Volts (V)	Cap	Finish	Dimensions (mm)		Energy Rating	Order Qty
					Dia	H		
Single Carton								
SIG15ABC	15	240	BC-B22d	Amber	28	58	E	10
SIG15ASES	15	240	SES-E14	Amber	28	63	E	10
SIG15BBC	15	240	BC-B22d	Blue	28	58	E	10
SIG15BSES	15	240	SES-E14	Blue	28	63	E	10
SIG15GBC	15	240	BC-B22d	Green	28	58	E	10
SIG15GSES	15	240	SES-E14	Green	28	63	E	10
SIG15PIBC	15	240	BC-B22d	Pink	28	58	E	10
SIG15PISES	15	240	SES-E14	Pink	28	63	E	10
SIG15RBC	15	240	BC-B22d	Red	28	58	E	10
SIG15RSBC	15	240	SBC-B15d	Red	28	62	E	10
SIG15RSES	15	240	SES-E14	Red	28	63	E	10
SIG15WBC	15	240	BC-B22d	White	28	58	E	10
SIG15WSES	15	240	SES-E14	White	28	63	E	10
SIG15YBC	15	240	BC-B22d	Yellow	28	58	E	10
SIG15YSES	15	240	SES-E14	Yellow	28	63	E	10

See page 67 for LED alternative

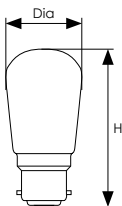

BC-B22d Cap



SES-E14 Cap



Colourglazed lamps provide strong vibrant colours as an alternative to the sparkling appearance of the Harlequin lamp. The coating is applied internally and will not wear away, which combined with the rough service vacuum construction to resist vibration, makes them ideal for outdoor applications where dirt and dust is encountered. Round lamps are often used when the lamp forms in integral part of the luminaire design.

- 1,000 hour life
- Suitable for outdoor use
- Choice of 7 colour finishes
- BC-B22d cap
- Internally fused for safety



Product Code	Watts (W)	Volts (V)	Cap	Finish	Dimensions (mm)		Energy Rating	Order Qty
					Dia	H		
Single Carton								
ROU15ABC-GLZ	15	240	BC-B22d	Amber	45	70	E	10
ROU15BBC-GLZ	15	240	BC-B22d	Blue	45	70	E	10
ROU15GBC-GLZ	15	240	BC-B22d	Green	45	70	E	10
ROU15WBC-GLZ	15	240	BC-B22d	White	45	70	E	10
ROU15RBC-GLZ	15	240	BC-B22d	Red	45	70	E	10
ROU15YBC-GLZ	15	240	BC-B22d	Yellow	45	70	E	10
ROU15CBC-GLZ	15	240	BC-B22d	Clear	45	70	E	10

See page 65 for LED alternative

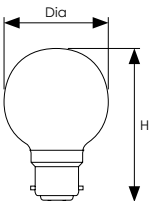

BC-B22d Cap



Crompton
LAMPS



LED

Harlequin Coloured GLS and Round



- Internally applied fade resistant colour
- IP65 rated
can be used outdoors in a suitable IP65 rated socket
- BC-B22d and ES-E27 caps
- Harlequin coloured lamps
available in blue, green, orange,
pink, purple, red, white and yellow



View our full range of innovative LED Products



www.cromptonlamps.com

Crompton
LAMPS

Tubular fridge lamp in a choice of cap types to provide compatibility with the majority of domestic and commercial upright refrigerators.

- 1,000 hour life
- SES-E14 or SBC-B15d cap
- Internally fused for safety



Product Code	Watts (W)	Volts (V)	Cap	Finish	Dimensions (mm)		Energy Rating	Order Qty
					Dia	H		
Single Carton								
AF15CSBC	15	240	SBC-B15d	Clear	22	55		10
AF15CSES	15	240	SES-E14	Clear	22	56		10

See page 77 for LED alternative

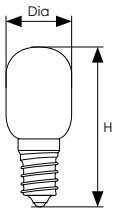

SBC-B15d Cap





SES-E14 Cap



High temperature resistant lamps in a choice of wattages to satisfy most oven applications.



- 1,000 hour life
- 300°C temperature rating
- SES-E14 cap
- Internally fused for safety

Product Code	Watts (W)	Volts (V)	Cap	Finish	Dimensions (mm)		Energy Rating	Order Qty
					Dia	H		
Single Carton								
AO15CSES	15	240	SES-E14	Clear	22	50		10
AO25CSES	25	240	SES-E14	Clear	22	50		10
AO40CSES	40	240	SES-E14	Clear	40	70		10

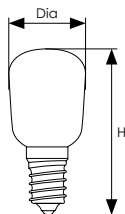
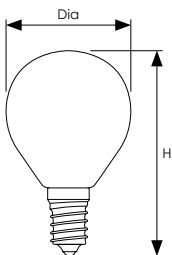



Microwave



Microwave lamps are specially designed to provide light in most types of microwave ovens.

- 1,000 hour life
- E17 or SES-E14 cap
- Internally fused for safety



Product Code	Watts (W)	Volts (V)	Cap	Finish	Dimensions (mm)		Energy Rating	Order Qty
					Dia	H		
Single Carton								
AM15CE17	15	240	E17	Clear	22	50		10
AM25CSES	25	240	SES-E14	Clear	22	56		10

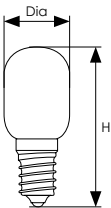

Icon Explanation

	Horizontal operation only with angle of tolerance shown
	Universal operating position
	Vertical operation only with angle of tolerance shown
	Indoor use only
	Suitable for outdoor use
	IP Rating tolerance shown
	Suitable for bathroom zones tolerance shown
	IK impact rating tolerance shown
	Class I
	Class II
	Spot component dimmable
	Accent rim light dimmable
	Individual and group control via app
	Bluetooth app controlled
	Device uses a Bluetooth controller
	Product contains dual wattage selection switch
	Product is surface mountable
	Product is suitable for recessed installations, dimensions shown
	Touch sensitive control
	Device can be controlled via smart device or home hub
	Automatic low light control sensor
	Glass retention coating to IEC 61549 standard

	Rough Service lamp
	Double life lamp
	UV stop glass
	Dimmable
	Non dimmable
	Dimmable & non dimmable versions
	Integrated Dimmer
	Dimmable via smart app or other smart Wi-Fi device
	Suitable for recycling
	Warranty period for non LED products, length of warranty shown
	Warranty period for LED products, length of warranty shown
	Product backed by 1 year on-site warranty, contact customer services for details
	Suitable for fire rated luminaires
	Fire Rated - Part L Compliant of UK Building Regulations, Part B Compliant BS476 Parts 21 and 22.
	Flicker free illumination, helps to prevent eye strain
	Low glare UGR<19 rated product
	Colour temperature in Kelvin and Colour name
	Product contains tuneable white light output, see description
	Product contains RGB colour lighting
	Lamp contains CCT switch (colour changing technology)
	Suitable for use as an emergency fitting, rechargeable 3 hour battery included
	Contains PIR or Microwave sensor to detect motion
	Suitable for inspection lamps

Crompton Lamps Limited Warranty

The following is effective from 1st January 2019 on all UK & Ireland sales:

LED Lamps

- 2 Year Warranty: All lamps rated $\leq 10,000$ hours life (L70)
- 3 Year Warranty: All lamps rated 10,001 - 20,000 hours life (L70)
- 4 Year Warranty: All lamps rated 20,001 - 30,000 hours life (L70)
- 5 year Warranty: All lamps rated 30,001 hours life (L70)



Phoebe LED Fittings

For individual warranty details, refer to the original product packaging, or visit our website, www.cromptonlamps.com

Terms & Conditions:

A lamp/luminaire is considered defective or faulty if either of the following occurs:

- It fails before the end of the Rated Life in hours stated on the product box.
- The lumens fall below 70% of the Lumens stated on the product box.

This warranty only covers products applied within 'intended' or 'normal use' as defined by:

- The operating conditions are in accordance with the information supplied on the packaging, the product or the Crompton Lamps/Phoebe LED website.
- The burning period must not exceed 4,000 hours per year.
- The ambient temperature never exceeds the operating temperature range of -20°C to 30°C unless otherwise stated on the packaging.
- The relative humidity (RH) in the installation doesn't exceed 80% RH, or exceed the IP rating of the lamp/luminaire if relevant.
- The lamp is operated in an open luminaire with a minimum of 10mm spacing around the body of the lamp with the exception of the cap.
- The lamp/luminaire is not subjected to more than the stated switching cycles on the packaging. Switching cycle is defined as the sequence of switching the lamp on and off at set intervals of 30 seconds.
- The electrical installation in which the lamp operates is not subjected to voltage fluctuations in a range exceeding 230V +/- 10%.

This warranty is supplementary to our published standard Terms & Conditions of Sale and is based on ERP performance criteria and lifetime calculations/verification from the user. The warranty is only available within the UK and Ireland. This warranty does not affect the statutory rights of the purchaser.

The warranty period starts from the date the products were purchased/invoiced prior to final installation. The faulty or defective product must be returned to Crompton Lamps along with the receipt and postage paid by the sender. The warranty covers a one for one replacement product if it fails within the warranty period. The company reserve the right to repair or offer a replacement to a similar or better performance at the company's discretion.

The company is not liable for any consequential loss or rectification costs in relation to this warranty, and does not include any removal or re-installation activities, labour costs or expenses. Crompton Lamps reserves the right to carry out an audit of the lighting installation and test the concerned lamps to determine the cause of failure & applicability of the Warranty. At the company's request, access shall be given to the installation in order to carry out the necessary quality inspections to determine the failure cause.

Crompton Lamps reserves the right to make the final decision on the validity of all warranty claims.

Exclusions:

This Warranty does not cover any of the following:

- Damage due to misuse or negligence.
- Failures caused by acts of God / Acts of Terrorism.
- Installations in violation of any applicable standard, code or instruction or incorrect voltage.

Lighting brilliance since 1878

Index

Part Code	Product Description	Cap	Page
3002	10W LED Dim AR111 2700K		82
3019	10W LED Dim AR111 4000K		82
3026	14W LED Dim AR111 2700K		82
3033	14W LED Dim AR111 4000K		82
3293	5W LED Glass 12V MR16 2700K	GU5.3	75
3309	5W LED Glass 12V MR16 4000K	GU5.3	75
3415	2.5W LED G9 Capsule 2700K	G9	78
3422	2.5W LED G9 Capsule 4000K	G9	78
4023	11W CFL T4 Stick Lamp 2700K	BC-B22d	94
4184	5W LED Filament Clear GLS Dim 2700K	BC-B22d	47
4191	5W LED Filament Clear GLS Dim 2700K	ES-E27	47
4207	7.5W LED Filament Clear GLS Dim 2700K	BC-B22d	47
4214	7.5W LED Filament Clear GLS Dim 2700K	ES-E27	47
4221	5W LED Ant. Filament ST64 Dim 2200K	BC-B22d	52
4238	5W LED Ant. Filament ST64 Dim 2200K	ES-E27	52
4245	7.5W LED Ant. Filament ST64 Dim 2200K	BC-B22d	52
4252	7.5W LED Ant. Filament ST64 Dim 2200K	ES-E27	52
4269	5W LED Ant. Filament G80 Dim 2200K	BC-B22d	52
4276	5W LED Ant. Filament G80 Dim 2200K	ES-E27	52
4283	5W LED Ant. Filament G95 Dim 2200K	BC-B22d	52
4290	5W LED Ant. Filament G95 Dim 2200K	ES-E27	52
4306	7.5W LED Ant. Filament G125 Dim 2200K	BC-B22d	52
4313	7.5W LED Ant. Filament G125 Dim 2200K	ES-E27	52
4467	4W LED Filament Round Clear 2700K	ES-E27	48
4504	13W LED Coloured PAR38 Red	ES-E27	68
4511	13W LED Coloured PAR38 Yellow	ES-E27	68
4528	13W LED Coloured PAR38 Blue	ES-E27	68
4870	4.5W LED Glass GU10 SMD 2700K	GU10	71
4887	4.5W LED Glass GU10 SMD 4000K	GU10	71
4891	Mini Link-Light Slat-Wall Header Card		31
4892	Mini Link-Light Interactive Display Board		31
4893	Mini Link-Light Pack of 50 Flyers		31
4894	2.5W LED Mini Link-Light 15cm 3000K		30
4900	5W LED Mini Link-Light 30cm 3000K		30
4917	9W LED Mini Link-Light 60cm 3000K		30
4931	2.5W LED Mini Link-Light 15cm 4000K		30
4948	5W LED Mini Link-Light 30cm 4000K		30
4955	9W LED Mini Link-Light 60cm 4000K		30
4962	15W LED Mini Link-Light 100cm 4000K		30
4979	20W Mini Link-Light Driver & On/Off Switch		30
4993	60W Mini Link-Light Driver & On/Off Switch		30
5006	120W Mini Link-Light Driver & On/Off Switch		30
5013	Mini Link-Light Touch Sensitive On/Off Switch		30
5020	Mini Link-Light Touch Sensitive Dimmer Switch		30
5037	Mini Link-Light Motion Sensor On/Off Switch		30
5051	Mini Link-Light Link-Lead (M2M)		31
5068	Mini Link-Light 4-Way Adapter Lead		31
5075	Mini Link-Light 2-Way Connector Left		31
5082	Mini Link-Light 2-Way Connector Right		31

Part Code	Product Description	Cap	Page
5099	Mini Link-Light 3-Way Connector T-Shaped		31
5105	Mini Link-Light 4-Way Connector		31
5112	Mini Link-Light Internal Corner Connector		31
5136	Mini Link-Light 45° Mounting Brackets (4)		31
5228	Manto Non-Corrosive IP65 5ft Single T8 Batten		15
5235	Manto Non-Corrosive IP65 6ft Single T8 Batten		15
5242	Manto Non-Corrosive IP65 5ft Twin T8 Batten		15
5259	Manto Non-Corrosive IP65 6ft Twin T8 Batten		15
5532	Manto Stainless Steel Spare Clip Pack 5ft		15
5549	Manto Stainless Steel Spare Clip Pack 6ft		15
5570	8W 2ft LED T5 Retrofit Tube 4000K	G5	88
5587	12W 3ft LED T5 Retrofit Tube 4000K	G5	88
5624	3.5W LED DET 221mm 2700K	SCC-S15	81
5631	6W LED DET 284mm 2700K	SCC-S15	81
5648	Mini Link-Light Link Lead (M2F)		31
5730	3.5W LED 12V MR11 SMD 2700K	GU4	76
5747	3.5W LED 12V MR11 SMD 4000K	GU4	76
5938	5W LED Filament Pearl GLS Dim 2700K	BC-B22d	50
5945	5W LED Filament Pearl GLS Dim 2700K	ES-E27	50
5952	7.5W LED Filament Pearl GLS Dim 2700K	BC-B22d	50
5969	7.5W LED Filament Pearl GLS Dim 2700K	ES-E27	50
6003	4W LED Filament Round Pearl 2700K	ES-E27	51
6010	4W LED Filament Round Pearl 2700K	SES-E14	51
6102	5W LED Glass GU10 SMD Dim 2700K	GU10	71
6119	5W LED Glass GU10 SMD Dim 4000K	GU10	71
6188	10W Terra LED Garden Spike 4000K		29
6591	6W LED Ant. Sp. Filament ST64 Dim 2200K	BC-B22d	53
6607	6W LED Ant. Sp. Filament ST64 Dim 2200K	ES-E27	53
6614	6W LED Ant. Sp. Filament G80 Dim 2200K	BC-B22d	53
6621	6W LED Ant. Sp. Filament G80 Dim 2200K	ES-E27	53
6713	35W Ares LED Track Spot-Light Black 3000K		39
6720	35W Ares LED Track Spot-Light Black 4000K		39
6737	35W Ares LED Track Spot-Light White 3000K		39
6744	35W Ares LED Track Spot-Light White 4000K		39
7093	2W 12V LED G4 Capsule 2700K	G4	78
7109	2W 12V LED G4 Capsule 4000K	G4	78
7130	5W LED Filament Candle Clear Dim 2700K	BC-B22d	48
7147	5W LED Filament Candle Clear Dim 2700K	SBC-B15d	48
7154	5W LED Filament Candle Clear Dim 2700K	ES-E27	48
7161	5W LED Filament Candle Clear Dim 2700K	SES-E14	48
7178	5W LED Filament Candle Pearl Dim 2700K	BC-B22d	51
7185	5W LED Filament Candle Pearl Dim 2700K	SBC-B15d	51
7192	5W LED Filament Candle Pearl Dim 2700K	ES-E27	51
7208	5W LED Filament Candle Pearl Dim 2700K	SES-E14	51
7215	5W LED Filament Round Clear Dim 2700K	BC-B22d	48
7222	5W LED Filament Round Clear Dim 2700K	SBC-B15d	48
7239	5W LED Filament Round Clear Dim 2700K	ES-E27	48
7246	5W LED Filament Round Clear Dim 2700K	SES-E14	48
7253	5W LED Filament Round Pearl Dim 2700K	BC-B22d	51

Index

Part Code	Product Description	Cap	Page
7260	5W LED Filament Round Pearl Dim 2700K	S8C-B15d	51
7277	5W LED Filament Round Pearl Dim 2700K	ES-E27	51
7284	5W LED Filament Round Pearl Dim 2700K	SES-E14	51
7307	6W LED R63 Thermal Plastic 2700K	BC-B22d	60
8854	3.5W LED DET 221mm 4000K	SCC-S15	81
8861	6W LED DET 284mm 4000K	SCC-S15	81
9066	1.3W LED Coloured Sign Amber	SES-E14	67
9073	1.3W LED Coloured Sign Blue	SES-E14	67
9080	1.3W LED Coloured Sign Green	SES-E14	67
9097	1.3W LED Coloured Sign Red	SES-E14	67
9103	1.3W LED Coloured Sign Yellow	SES-E14	67
9127	12.5W 12V LED AR111 Direct Retrofit 3000K	G53	83
9226	5.5W LED Candle Th. Plastic Dim 2700K	ES-E27	57
9240	5.5W LED Candle Th. Plastic Dim 4000K	BC-B22d	57
9271	5.5W LED Candle Th. Plastic Dim 6500K	BC-B22d	57
9288	5.5W LED Candle Th. Plastic Dim 6500K	ES-E27	57
9301	5.5W LED Round Th. Plastic Dim 2700K	BC-B22d	59
9318	5.5W LED Round Th. Plastic Dim 2700K	S8C-B15d	59
9325	5.5W LED Round Th. Plastic Dim 2700K	ES-E27	59
9332	5.5W LED Round Th. Plastic Dim 2700K	SES-E14	59
9349	5.5W LED Round Th. Plastic Dim 4000K	BC-B22d	59
9370	5.5W LED Round Th. Plastic Dim 6500K	BC-B22d	59
9387	5.5W LED Round Th. Plastic Dim 6500K	ES-E27	59
9394	5.5W LED Round Th. Plastic Dim 6500K	SES-E14	59
9417	10W Spectrum LED Downlight RGB 2200K-6500K		6
9479	4.5W LED Coloured GU10 Red	GU10	66
9479	4.5W LED Coloured GU10 Yellow	GU10	66
9585	25W Alecto Dim Track Spot-Light Black 4000K		38
9592	25W Alecto Dim Track Spot-Light White 4000K		38
9615	9.5W LED GLS Dusk till Dawn 2700K	BC-B22d	62
9738	5.5W LED GU10 Sunset Dim	GU10	73
9752	8W 2ft LED T5 Retrofit Tube 3000K	G5	88
9769	12W 3ft LED T5 Retrofit Tube 3000K	G5	88
9776	16W 4ft LED T5 Retrofit Tube 3000K	G5	88
9783	20W 5ft LED T5 Retrofit Tube 3000K	G5	88
9943	12.5W 12V LED AR111 Direct Retrofit 4000K G53		83
9950	12.5W LED AR111 Direct to Mains 3000K	GU10	83
9967	12.5W LED AR111 Direct to Mains 4000K	GU10	83
9974	3W G9 Capsule Sunset Dim	G9	78
10222	16W LED 2D Retrofit 3500K	4-Pin	85
10406	37W Electra Scoop Light 3000K		33
10413	37W Electra Scoop Light 4000K		33
10420	Spectrum Smart Switch		7
10505	Spectrum Gloss Black Bezel		6
10512	Spectrum Antique Brass Bezel		6
10536	18.5W Atlanta LED Universal 3000K		5
10543	18.5W Atlanta LED Universal 4000K		5
10611	Manto Non-Corrosive IP65 4ft Single T8 Batten		15
10666	Phoebe Track 2m 3-Circuit Track White		35

Part Code	Product Description	Cap	Page
10680	Phoebe Track Left Live End Feed White		35
10697	Phoebe Track Right Live End Feed White		35
10703	Phoebe Track End Cap White		35
10727	Phoebe Track Left Coupler White		35
10734	Phoebe Track Right Coupler White		35
10741	Phoebe Track X-Coupler White		37
10758	Phoebe Track T-Coupler Left Inside White		36
10765	Phoebe Track T-Coupler Left Outside White		36
10772	Phoebe Track T-Coupler Right Inside White		36
10789	Phoebe Track T-Coupler Right Outside White		36
10796	Phoebe Track Flexible Coupler White		37
10802	Phoebe Track Rigid Suspension Kit White		37
10819	Phoebe Track Wire Suspension Kit White		37
10826	Phoebe Track 1m 3-Circuit Track Black		35
10833	Phoebe Track 2m 3-Circuit Track Black		35
10840	Phoebe Track 3m 3-Circuit Track Black		35
10857	Phoebe Track Left Live End Feed Black		35
10864	Phoebe Track Right Live End Feed Black		35
10871	Phoebe Track End Cap Black		35
10888	Phoebe Track Coupler Black		35
10895	Phoebe Track Left Coupler Black		35
10901	Phoebe Track Right Coupler Black		35
10918	Phoebe Track X-Coupler Black		37
10925	Phoebe Track T-Coupler Left Inside Black		36
10932	Phoebe Track T-Coupler Left Outside Black		36
10949	Phoebe Track T-Coupler Right Inside Black		36
10956	Phoebe Track T-Coupler Right Outside Black		36
10963	Phoebe Track Flexible Coupler Black		37
10970	Phoebe Track Rigid Suspension Kit Black		37
10987	Phoebe Track Wire Suspension Kit Black		37
10994	6W LED Linear 78mm 3000K	R7s	79
11014	9W LED Linear 118mm 3000K	R7s	79
11038	20W Manto Integrated 2 4ft Sensor		16
11045	20W Manto Integrated 2 4ft 3-Hour Emergency		16
11069	40W Manto Integrated 2 4ft HO Sensor		16
11076	40W Manto Integrated 2 4ft HO 3-Hr Emergency		16
11090	30W Manto Integrated 2 5ft Sensor		16
11106	30W Manto Integrated 2 5ft 3-Hr Emergency		16
11120	60W Manto Integrated 2 5ft HO Sensor		16
11137	60W Manto Integrated 2 5ft HO 3-Hr Emergency		16
11144	7.5W LED Th. Plastic Stick Lamp 3000K	BC-B22d	63
11151	7.5W LED Th. Plastic Stick Lamp 3000K	ES-E27	63
11229	5W LED Thermal Plastic GU10 3000K	GU10	70
11236	5W LED Thermal Plastic GU10 4000K	GU10	70
11298	5.5W LED Candle Thermal Plastic 2700K	BC-B22d	56
11304	5.5W LED Candle Thermal Plastic 2700K	S8C-B15d	56
11311	5.5W LED Candle Thermal Plastic 2700K	ES-E27	56
11328	5.5W LED Candle Thermal Plastic 2700K	SES-E14	56
11335	5.5W LED Candle Thermal Plastic 4000K	BC-B22d	56

Index

Part Code	Product Description	Cap	Page
11342	5.5W LED Candle Thermal Plastic 4000K	ES-E27	56
11359	5.5W LED Candle Thermal Plastic 4000K	SES-E14	56
11366	5.5W LED Candle Thermal Plastic 6500K	BC-B22d	56
11373	5.5W LED Candle Thermal Plastic 6500K	ES-E27	56
11380	5.5W LED Candle Thermal Plastic 6500K	SES-E14	56
11496	5.5W LED Round Thermal Plastic 2700K	BC-B22d	58
11502	5.5W LED Round Thermal Plastic 2700K	SBC-B15d	58
11519	5.5W LED Round Thermal Plastic 2700K	ES-E27	58
11526	5.5W LED Round Thermal Plastic 2700K	SES-E14	58
11533	5.5W LED Round Thermal Plastic 4000K	BC-B22d	58
11540	5.5W LED Round Thermal Plastic 4000K	ES-E27	58
11557	5.5W LED Round Thermal Plastic 4000K	SES-E14	58
11564	5.5W LED Round Thermal Plastic 6500K	BC-B22d	58
11571	5.5W LED Round Thermal Plastic 6500K	ES-E27	58
11588	5.5W LED Round Thermal Plastic 6500K	SES-E14	58
11694	5.5W LED GLS Thermal Plastic 2700K	BC-B22d	54
11700	5.5W LED GLS Thermal Plastic 2700K	ES-E27	54
11717	8.5W LED GLS Thermal Plastic 2700K	BC-B22d	54
11724	8.5W LED GLS Thermal Plastic 2700K	ES-E27	54
11731	8.5W LED GLS Thermal Plastic 4000K	BC-B22d	54
11748	8.5W LED GLS Thermal Plastic 4000K	ES-E27	54
11755	11W LED GLS Thermal Plastic 2700K	BC-B22d	54
11762	11W LED GLS Thermal Plastic 2700K	ES-E27	54
11779	11W LED GLS Thermal Plastic 4000K	BC-B22d	54
11786	11W LED GLS Thermal Plastic 4000K	ES-E27	54
11793	11W LED GLS Thermal Plastic 6500K	BC-B22d	54
11809	11W LED GLS Thermal Plastic 6500K	ES-E27	54
11816	11W LED GLS Thermal Plastic Dim 2700K	BC-B22d	55
11823	11W LED GLS Thermal Plastic Dim 2700K	ES-E27	55
11830	11W LED GLS Thermal Plastic Dim 4000K	BC-B22d	55
11847	11W LED GLS Thermal Plastic Dim 4000K	ES-E27	55
11854	11W LED GLS Thermal Plastic Dim 6500K	BC-B22d	55
11861	11W LED GLS Thermal Plastic Dim 6500K	ES-E27	55
11878	15W LED GLS Thermal Plastic 2700K	BC-B22d	54
11885	15W LED GLS Thermal Plastic 2700K	ES-E27	54
11892	14W LED GLS Thermal Plastic Dim 2700K	BC-B22d	55
11908	14W LED GLS Thermal Plastic Dim 2700K	ES-E27	55
11915	9W 110V GLS Thermal Plastic 2700K	BC-B22d	61
11922	9W 110V GLS Thermal Plastic 2700K	ES-E27	61
12042	9W 110V GLS Thermal Plastic 2700K 4000K	BC-B22d	61
12059	25W LED PLL Direct to Mains 4000K	2G11	80
12066	14W 4ft LED T5 Direct to Mains Tube 4000K G5		89
12073	20W 5ft LED T5 Direct to Mains Tube 4000K G5		89
12080	8W 2ft LED T5 Direct to Mains Tube 4000K G5		89
12097	12W 3ft LED T5 Direct to Mains Tube 4000K G5		89
12103	100W Atlas LED Commercial Floodlight		21
12110	150W Atlas LED Commercial Floodlight		21
12127	200W Atlas LED Commercial Floodlight		21

Part Code	Product Description	Cap	Page
12134	5W LED Bent-Tip Candle Dim 2700K	BC-B22d	49
12141	5W LED Bent-Tip Candle Dim 2700K	SBC-B15d	49
12158	5W LED Bent-Tip Candle Dim 2700K	ES-E27	49
12165	5W LED Bent-Tip Candle Dim 2700K	SES-E14	49
12172	6.5W Atlanta LED Universal Dim 3000K		5
12189	6.5W Atlanta LED Universal Dim 4000K		5
12196	18.5W Atlanta LED Universal Dim 3000K		5
12202	18.5W Atlanta LED Universal Dim 4000K		5
12219	40W Photius Integrated CCT 4ft Standard		19
12226	40W Photius Integrated CCT 4ft Microwave Sensor		19
12233	40W Photius Integrated CCT 4ft Emergency Sensor		19
12240	60W Photius Integrated CCT 5ft Standard		19
12257	60W Photius Integrated CCT 5ft Microwave Sensor		19
12264	60W Photius Integrated CCT 5ft Emergency Sensor		19
12301	9W 8.5W LED Smart GLS 3000K	BC-B22d	43
12318	9W 8.5W LED Smart GLS 3000K	ES-E27	43
12325	9W 8.5W LED Smart GLS RGBW 3000K	BC-B22d	43
12332	9W 8.5W LED Smart GLS RGBW 3000K	ES-E27	43
12349	5W LED Smart Candle 3000K	BC-B22d	44
12356	5W LED Smart Candle 3000K	SES-E14	44
12363	5W LED Smart Candle RGBW 3000K	BC-B22d	44
12370	5W LED Smart Candle RGBW 3000K	SES-E14	44
12387	5W LED Smart 2700K-4000K	GU10	45
12394	5W LED Smart RGBW 3000K	GU10	45
12400	5W LED Smart RGBW 4000K	GU10	45
12417	18W LED Smart 5m Flexi-Strip Kit RGBW 2700K-6500K		46
12431	100W Keto Highbay 90° Lens 4000K		22
12448	150W Keto Highbay 90° Lens 4000K		22
12455	200W Keto Highbay 90° Lens 4000K		22
12462	100W Keto Highbay 60° Lens 4000K		22
12479	150W Keto Highbay 60° Lens 4000K		22
12486	200W Keto Highbay 60° Lens 4000K		22
12493	20W 5M LED Flexi Strip-Light Kit WW 2700K		32
12509	20W 5M LED Flexi Strip-Light Kit CW 4000K		32
12516	32W 5M LED Flexi Strip-Light Kit RGB		32
12523	48W WW/CW 10m Driver		32
12530	60W RGB 10m Driver		32
12547	Accessory Kit for LED Flexi Strip-Light Kits		32
12554	10W Atlas-Mini LED Floodlight 4000K		20
12561	20W Atlas-Mini LED Floodlight 4000K		20
12578	30W Atlas-Mini LED Floodlight 4000K		20
12585	50W Atlas-Mini LED Floodlight 4000K		20
12592	10W Atlas-Mini LED Floodlight PIR 4000K		20
12608	20W Atlas-Mini LED Floodlight PIR 4000K		20
12615	30W Atlas-Mini LED Floodlight PIR 4000K		20
12622	50W Atlas-Mini LED Floodlight PIR 4000K		20
12639	8.5W Firesafe All-In-One CCT		9
12684	5W 6W LED GX53 2700K	GX53	84

Index

Part Code	Product Description	Cap	Page
12691	5W 6W LED GX53 4000K	GX53	84
12707	3W LED R39 Thermal Plastic 2700K	SES-E14	60
12714	6W LED R50 Thermal Plastic 2700K	SES-E14	60
12721	8W LED R63 Thermal Plastic 2700K	ES-E27	60
12738	10W LED R80 Thermal Plastic 2700K	ES-E27	60
12745	18W LED PAR38 3000K	ES-E27	69
12752	10W LED PAR30 3000K	ES-E27	69
12820	2.7W LED Pygmy/Sign/Fridge 2700K	SES-E14	77
12837	4.7W 3.8W Filament Cooker Hood 2700K	SES-E14	77
12844	4.7W 3.8W Filament Cooker Hood 4000K	SES-E14	77
12851	8.5W Firesafe Smart LED Downlight 3000K-6500K		42
12868	6.7W Firesafe Eco 3000K		8
12875	6.7W Firesafe Eco 4000K		8
13452	5.5W LED Long Barrel L1/GU10 2700K	GU10	74
13469	5.5W LED Long Barrel L1/GU10 4000K	GU10	74
13476	5W 5.LED Candle Th. Plastic Dim 2700K	BC-B22d	57
13490	5W 5.LED Candle Th. Plastic Dim 2700K	SES-E14	57
13513	5W 5.LED Candle Th. Plastic Dim 4000K	ES-E27	57
13520	5W 5.LED Candle Th. Plastic Dim 4000K	SES-E14	57
13551	5W 5.LED Candle Th. Plastic Dim 6500K	SES-E14	57
13605	5W LED Round Thermal Plastic Dim 4000K	ES-E27	59
13612	5W LED Round Thermal Plastic Dim 4000K	SES-E14	59
13650	4.5W LED Harlequin GLS Blue	BC-B22d	64
13667	4.5W LED Harlequin GLS Blue	ES-E27	64
13674	4.5W LED Harlequin GLS Green	BC-B22d	64
13681	4.5W LED Harlequin GLS Green	ES-E27	64
13698	4.5W LED Harlequin GLS Orange	BC-B22d	64
13704	4.5W LED Harlequin GLS Orange	ES-E27	64
13711	4.5W LED Harlequin GLS Pink	BC-B22d	64
13728	4.5W LED Harlequin GLS Pink	ES-E27	64
13735	4.5W LED Harlequin GLS Purple	BC-B22d	64
13742	4.5W LED Harlequin GLS Purple	ES-E27	64
13759	4.5W LED Harlequin GLS Red	BC-B22d	64
13766	4.5W LED Harlequin GLS Red	ES-E27	64
13773	4.5W LED Harlequin GLS White	BC-B22d	64
13780	4.5W LED Harlequin GLS White	ES-E27	64
13797	4.5W LED Harlequin GLS Yellow	BC-B22d	64
13803	4.5W LED Harlequin GLS Yellow	ES-E27	64
13810	4.5W LED Harlequin Round Blue	BC-B22d	65
13827	4.5W LED Harlequin Round Blue	ES-E27	65
13834	4.5W LED Harlequin Round Green	BC-B22d	65
13841	4.5W LED Harlequin Round Green	ES-E27	65
13858	4.5W LED Harlequin Round Orange	BC-B22d	65
13865	4.5W LED Harlequin Round Orange	ES-E27	65
13872	4.5W LED Harlequin Round Pink	BC-B22d	65
13889	4.5W LED Harlequin Round Pink	ES-E27	65
13896	4.5W LED Harlequin Round Purple	BC-B22d	65
13902	4.5W LED Harlequin Round Purple	ES-E27	65
13919	4.5W LED Harlequin Round Red	BC-B22d	65

Part Code	Product Description	Cap	Page
13926	4.5W LED Harlequin Round Red	ES-E27	65
13933	4.5W LED Harlequin Round White	BC-B22d	65
13940	4.5W LED Harlequin Round White	ES-E27	65
13957	4.5W LED Harlequin Round Yellow	BC-B22d	65
13964	4.5W LED Harlequin Round Yellow	ES-E27	65
13971	2.5W 4W Krios Emergency Bulkhead 6000K-7000K		24
13995	10.5W 2.3W Krios Emergency Twin Spot		25
14008	1W Krios Emergency Spot Round Lens		26
14015	1W Krios Emergency Spot Corridor Lens		26
14022	2W Krios Emergency Blade 6000K		27
14039	Krios Emergency Blade Legend Set - Up		27
14046	Krios Emergency Blade Legend Set - Left/Right		27
14060	2.5W 1.8W Krios Emergency Wall Box 6000K-7000K		28
14077	Krios Emergency Wall Box Legend Set - Up		28
14084	Krios Emergency Wall Box Legend Set - Left		28
14091	Krios Emergency Wall Box Legend Set - Right		28
14121	38W Galanos Arteson TP(a) UGR<19 Panel 3000K		13
14138	38W Galanos Arteson TP(a) UGR<19 Panel 4000K		13
14145	42309W 15W Melana Standard CCT		10
14152	42309W 15W Melana Sensor CCT		10
14169	43435W 15W Melana Emergency CCT		10
14176	43435W 15W Melana Sensor & Emergency CCT		10
14251	20W Lykos 4ft Batten CCT		17
14268	20W Lykos 4ft Batten 3-Hour Emergency CCT		17
14275	30W Lykos 5ft Batten CCT		17
14282	30W Lykos 5ft Batten 3-Hour Emergency CCT		17
14299	40W Lykos High Output (HO) 4ft Batten CCT		17
14305	40W Lykos HO 4ft Batten 3-Hour Emergency CCT		17
14312	60W Lykos High Output (HO) 5ft Batten CCT		17
14329	60W Lykos HO 5ft Batten 3-Hour Emergency CCT		17
14336	80W Lykos High Output (HO) 6ft Batten CCT		17
14343	80W Lykos HO 6ft Batten 3-Hour Emergency CCT		17
14350	20W Oracle 4ft Batten CCT		18
14367	20W Oracle 4ft Batten 3-Hour Emergency CCT		18
14374	30W Oracle 5ft Batten CCT		18
14381	30W Oracle 5ft Batten 3-Hour Emergency CCT		18
14398	40W Oracle 6ft Batten CCT		18
14404	40W Oracle 6ft Batten 3-Hour Emergency CCT		18
14411	40W Oracle High Output (HO) 4ft Batten CCT		18
14428	40W Oracle HO 4ft Batten 3-Hour Emergency CCT		18
14435	60W Oracle High Output (HO) 5ft Batten CCT		18
14442	60W Oracle HO 5ft Batten 3-Hour Emergency CCT		18
14459	80W Oracle High Output (HO) 6ft Batten CCT		18
14466	80W Oracle HO 6ft Batten 3-Hour Emergency CCT		18
14473	40W Galanos Arteson TP(b) 600x600 Panel 3000K		13
14480	40W Galanos Arteson TP(b) 600x600 Panel 4000K		13
14497	40W Galanos Arteson TP(b) 600x600 Panel 6000K		13
14503	40W Galanos Arteson TP(a) 1200x300 Panel 4000K		13
14510	Wire suspension kit for Galanos Arteson		13

Index

Part Code	Product Description	Cap	Page
14527	40W 3-hour emergency kit for Galanos		13
14534	600x600 surface mounting kit for Galanos Arteson		13
14541	1200x300 surface mounting kit for Galanos Arteson		13
14558	5W 5.LED Candle Th. Plastic Dim 2700K	SBC-B15d	57
14565	Krios Emergency Blade Suspension Kit		27
14572	Krios Emergency Blade Recessed Kit		27
14589	12W Savoca Standard CCT		12
14596	12W Savoca Sensor CCT		12
14602	12W Savoca Emergency CCT		12
14619	12W Savoca Sensor & Emergency CCT		12
14626	18W Savoca Standard CCT		12
14633	18W Savoca Sensor CCT		12
14640	18W Savoca Emergency CCT		12
14657	18W Savoca Sensor & Emergency CCT		12
14671	Intelligent touch sensitive Wi-Fi dimmer switch		40
14688	Melana CCT Optional Eyelid Cover		10
14695	Melana CCT Optional Grille Cover		10
12646-10	Polished Chrome Bezel for Firesafe Downlights		8
25ABC-GLZ	25W Colouglazed GLS Amber	BC-B22d	118
25AES-GLZ	25W Colouglazed GLS Amber	ES-E27	118
25BBC-GLZ	25W Colouglazed GLS Blue	BC-B22d	118
25BES-GLZ	25W Colouglazed GLS Blue	ES-E27	118
25GBC-GLZ	25W Colouglazed GLS Green	BC-B22d	118
25GES-GLZ	25W Colouglazed GLS Green	ES-E27	118
25PIBC-GLZ	25W Colouglazed GLS Pink	BC-B22d	118
25PIES-GLZ	25W Colouglazed GLS Pink	ES-E27	118
25RBC-GLZ	25W Colouglazed GLS Red	BC-B22d	118
25RES-GLZ	25W Colouglazed GLS Red	ES-E27	118
25WBC-GLZ	25W Colouglazed GLS White	BC-B22d	118
25WES-GLZ	25W Colouglazed GLS White	ES-E27	118
25YBC-GLZ	25W Colouglazed GLS Yellow	BC-B22d	118
25YES-GLZ	25W Colouglazed GLS Yellow	ES-E27	118
40YBC-GLZ	40W Colouglazed GLS Yellow	BC-B22d	118
60ABC-GLZ	60W Colouglazed GLS Amber	BC-B22d	118
60BBC-GLZ	60W Colouglazed GLS Blue	BC-B22d	118
60PBC-GLZ	60W Colouglazed GLS Pink	BC-B22d	118
AF15CSBC	15W Fridge Appliance	SBC-B15d	123
AF15CSES	15W Fridge Appliance	SES-E14	123
AM15CE17	15W Microwave Appliance	E17	125
AM25CSES	25W Microwave Appliance	SES-E14	125
A015CSES	15W Oven Appliance	SES-E14	124
A025CSES	25W Oven Appliance	SES-E14	124
A040CSES	40W Oven Appliance	SES-E14	124
BPCFT211WWBC-1BL	11W CFL T2 Ultra Mini Spiral 2700K	BC-B22d	93
BPCFT211WWES-1BL	11W CFL T2 Ultra Mini Spiral 2700K	ES-E27	93
BPCFT215WWBC-1BL	15W CFL T2 Ultra Mini Spiral 2700K	BC-B22d	93
BPCFT215WVES-1BL	15W CFL T2 Ultra Mini Spiral 2700K	ES-E27	93

Part Code	Product Description	Cap	Page
BPCFT220WWBC-1BL	20W CFL T2 Ultra Mini Spiral 2700K	BC-B22d	93
BPCFT220WVES-1BL	20W CFL T2 Ultra Mini Spiral 2700K	ES-E27	93
BPCFT223WWBC-1BL	23W CFL T2 Ultra Mini Spiral 2700K	BC-B22d	93
CIR22SPCW	22W Fluorescent T9 Circular 4000K	4-Pin	105
CIR22SPWW	22W Fluorescent T9 Circular 3000K	4-Pin	105
CIR32PCW	32W Fluorescent T9 Circular 4000K	4-Pin	105
CIR32PWW	32W Fluorescent T9 Circular 3000K	4-Pin	105
CIR40PCW	40W Fluorescent T9 Circular 4000K	4-Pin	105
CIR40PWW	40W Fluorescent T9 Circular 3000K	4-Pin	105
CIR60PCW	60W Fluorescent T9 Circular 4000K	4-Pin	105
CIR60PWW	60W Fluorescent T9 Circular 3000K	4-Pin	105
CLC16CW2PIN	16W CFL CC 4000K	2-Pin	101
CLC16CW4PIN	16W CFL CC 4000K	4-Pin	101
CLC16W2PIN	16W CFL CC 3500K	2-Pin	101
CLC16W4PIN	16W CFL CC 3500K	4-Pin	101
CLC16WW2PIN	16W CFL CC 2700K	2-Pin	101
CLC16WW4PIN	16W CFL CC 2700K	4-Pin	101
CLC28CW2PIN	28W CFL CC 4000K	2-Pin	101
CLC28CW4PIN	28W CFL CC 4000K	4-Pin	101
CLC28W2PIN	28W CFL CC 3500K	2-Pin	101
CLC28W4PIN	28W CFL CC 3500K	4-Pin	101
CLC28WW2PIN	28W CFL CC 2700K	2-Pin	101
CLC28WW4PIN	28W CFL CC 2700K	4-Pin	101
CLC38CW4PIN	38W CFL CC 4000K	4-Pin	101
CLC38W4PIN	38W CFL CC 3500K	4-Pin	101
CLC38WW4PIN	38W CFL CC 2700K	4-Pin	101
CLD10SCW	10W CFL Double Turn D Type 4000K	2-Pin	98
CLD10SW	10W CFL Double Turn D Type 3500K	2-Pin	98
CLD10SWW	10W CFL Double Turn D Type 3000K	2-Pin	98
CLD13SCW	13W CFL Double Turn D Type 4000K	2-Pin	98
CLD13SW	13W CFL Double Turn D Type 3500K	2-Pin	98
CLD13SWW	13W CFL Double Turn D Type 3000K	2-Pin	98
CLD18SCW	18W CFL Double Turn D Type 4000K	2-Pin	98
CLD18SW	18W CFL Double Turn D Type 3500K	2-Pin	98
CLD18SWW	18W CFL Double Turn D Type 3000K	2-Pin	98
CLD26SCW	26W CFL Double Turn D Type 4000K	2-Pin	98
CLD26SW	26W CFL Double Turn D Type 3500K	2-Pin	98
CLD26SWW	26W CFL Double Turn D Type 3000K	2-Pin	98
CLDE10SCW	10W CFL Double Turn DE Type Dim 4000K	4-Pin	99
CLDE10SW	10W CFL Double Turn DE Type Dim 3500K	4-Pin	99
CLDE13SCW	13W CFL Double Turn DE Type Dim 4000K	4-Pin	99
CLDE13SW	13W CFL Double Turn DE Type Dim 3500K	4-Pin	99
CLDE13SWW	13W CFL Double Turn DE Type Dim 3000K	4-Pin	99
CLDE18SCW	18W CFL Double Turn DE Type Dim 4000K	4-Pin	99
CLDE18SW	18W CFL Double Turn DE Type Dim 3500K	4-Pin	99
CLDE18SWW	18W CFL Double Turn DE Type Dim 3000K	4-Pin	99
CLDE26SCW	26W CFL Double Turn DE Type Dim 4000K	4-Pin	99
CLDE26SW	26W CFL Double Turn DE Type Dim 3500K	4-Pin	99
CLDE26SWW	26W CFL Double Turn DE Type Dim 3000K	4-Pin	99

Index

Part Code	Product Description	Cap	Page
CLDE26SWW	26W CFL Double Turn DE Type Dim 3000K	4-Pin	99
CLL18SCW	18W CFL Single Turn L Type Dim 4000K	2G11	97
CLL24SCW	24W CFL Single Turn L Type Dim 4000K	2G11	97
CLL36SCW	36W CFL Single Turn L Type Dim 4000K	2G11	97
CLL40SCW	40W CFL Single Turn L Type Dim 4000K	2G11	97
CLL55SW	55W CFL Single Turn L Type Dim 3500K	2G11	97
CLS11SCW	11W CFL Single Turn S Type 4000K	2-Pin	95
CLS11SW	11W CFL Single Turn S Type 3500K	2-Pin	95
CLS11SWW	11W CFL Single Turn S Type 3000K	2-Pin	95
CLS5SCW	5W CFL Single Turn S Type 4000K	2-Pin	95
CLS5SW	5W CFL Single Turn S Type 3500K	2-Pin	95
CLS5SWW	5W CFL Single Turn S Type 3000K	2-Pin	95
CLS7SCW	7W CFL Single Turn S Type 4000K	2-Pin	95
CLS7SW	7W CFL Single Turn S Type 3500K	2-Pin	95
CLS7SWW	7W CFL Single Turn S Type 3000K	2-Pin	95
CLS9SCW	9W CFL Single Turn S Type 4000K	2-Pin	95
CLS9SW	9W CFL Single Turn S Type 3500K	2-Pin	95
CLS9SWW	9W CFL Single Turn S Type 3000K	2-Pin	95
CLSE11SCW	11W CFL Single Turn SE Type Dim 4000K	4-Pin	96
CLSE5SCW	5W CFL Single Turn SE Type Dim 4000K	4-Pin	96
CLSE7SCW	7W CFL Single Turn SE Type Dim 4000K	4-Pin	96
CLSE9SCW	9W CFL Single Turn SE Type Dim 4000K	4-Pin	96
CLTE13SCW	13W CFL Triple Turn TE Type 4000K	4-Pin	100
CLTE18SCW	18W CFL Triple Turn TE Type 4000K	4-Pin	100
CLTE18SW	18W CFL Triple Turn TE Type 3500K	4-Pin	100
CLTE26SCW	26W CFL Triple Turn TE Type 4000K	4-Pin	100
CLTE26SW	26W CFL Triple Turn TE Type 3500K	4-Pin	100
CLTE32SCW	32W CFL Triple Turn TE Type 4000K	4-Pin	100
CLTE32SW	32W CFL Triple Turn TE Type 3500K	4-Pin	100
CLTE42SCW	42W CFL Triple Turn TE Type 4000K	4-Pin	100
CLTE42SW	42W CFL Triple Turn TE Type 3500K	4-Pin	100
CRA100BC	100W Craflight GLS	BC-822d	115
CRA100ES	100W Craflight GLS	ES-E27	115
CRA60BC	60W Craflight GLS	BC-822d	115
CRA60ES	60W Craflight GLS	ES-E27	115
ETH120R7L	120W ESH Linear Dim 2700K	R7s	90
ETH120R7S	120W ESH Linear Dim 2700K	R7s	90
ETH160R7	160W ESH Linear Dim 2700K	R7s	90
ETH230R7	230W ESH Linear Dim 2700K	R7s	90
ETH230R7110	230W ESH Linear Dim 2700K	R7s	90
ETH400R7	400W ESH Linear Dim 2700K	R7s	90
ETH400R7110	400W ESH Linear Dim 2700K	R7s	90
ETH48R7	48W ESH Linear Dim 2700K	R7s	90
ETH80R7	80W ESH Linear Dim 2700K	R7s	90
ETH80R7L	80W ESH Linear Dim 2700K	R7s	90
ETHG918C	18W ESH G9 Capsule Dim 2700K	G9	91
ETHG933C	33W ESH G9 Capsule Dim 2700K	G9	91
ETHG942C	42W ESH G9 Capsule Dim 2700K	G9	91

Part Code	Product Description	Cap	Page
FIRCAN40BC	40W Fireglow Candle Red	BC-822d	116
FIRCAN40ES	40W Fireglow Candle Red	ES-E27	116
FIRCAN40SES	40W Fireglow Candle Red	SES-E14	116
FS125	Fluorescent Starter Switch 70W-125W	2 Pin	106
FS2	Fluorescent Starter Switch 4W-22W Series	2 Pin	106
FSU-10	Fluorescent Starter Switch 4W-65W	2 Pin	106
FT128CW	8W Fluorescent T5 4000K	G5	102
FT128W	8W Fluorescent T5 3500K	G5	102
FT128WW	8W Fluorescent T5 3000K	G5	102
FT1815SPCW	15W Fluorescent T8 4000K	G13	104
FT1815SPDYLTL	15W Fluorescent T8 6500K	G13	104
FT1815SPW	15W Fluorescent T8 3500K	G13	104
FT2113CW	13W Fluorescent T5 4000K	G5	102
FT2113W	13W Fluorescent T5 3500K	G5	102
FT218SPCW	18W Fluorescent T8 4000K	G13	104
FT218SPDYLTL	18W Fluorescent T8 6500K	G13	104
FT218SPW	18W Fluorescent T8 3500K	G13	104
FT218SPWW	18W Fluorescent T8 3000K	G13	104
FT330SPCW	30W Fluorescent T8 4000K	G13	104
FT330SPDYLTL	30W Fluorescent T8 6500K	G13	104
FT330SPW	30W Fluorescent T8 3500K	G13	104
FT436SPCW	36W Fluorescent T8 4000K	G13	104
FT436SPDYLTL	36W Fluorescent T8 6500K	G13	104
FT436SPW	36W Fluorescent T8 3500K	G13	104
FT436SPWW	36W Fluorescent T8 3000K	G13	104
FT588PCW	58W Fluorescent T8 4000K	G13	104
FT588PDYLTL	58W Fluorescent T8 6500K	G13	104
FT588PW	58W Fluorescent T8 3500K	G13	104
FT588PWW	58W Fluorescent T8 3000K	G13	104
FT670SPCW	70W Fluorescent T8 4000K	G13	104
FT670SPDYLTL	70W Fluorescent T8 6500K	G13	104
FT670SPW	70W Fluorescent T8 3500K	G13	104
FT96CW	6W Fluorescent T5 4000K	G5	102
FT96W	6W Fluorescent T5 3500K	G5	102
FTT514SPCW	14W Fluorescent T5 (HE) 4000K	G5	103
FTT514SPDYLTL	14W Fluorescent T5 (HE) 6500K	G5	103
FTT514SPW	14W Fluorescent T5 (HE) 3500K	G5	103
FTT521SPCW	21W Fluorescent T5 (HE) 4000K	G5	103
FTT521SPW	21W Fluorescent T5 (HE) 3500K	G5	103
FTT524SPCW	24W Fluorescent T5 (HO) 4000K	G5	103
FTT524SPDYLTL	24W Fluorescent T5 (HO) 6500K	G5	103
FTT528SPCW	28W Fluorescent T5 (HE) 4000K	G5	103
FTT528SPDYLTL	28W Fluorescent T5 (HE) 6500K	G5	103
FTT528SPW	28W Fluorescent T5 (HE) 3500K	G5	103
FTT535SPCW	35W Fluorescent T5 (HE) 4000K	G5	103
FTT535SPDYLTL	35W Fluorescent T5 (HE) 6500K	G5	103
FTT535SPW	35W Fluorescent T5 (HE) 3500K	G5	103
FTT539SPCW	39W Fluorescent T5 (HO) 4000K	G5	103

Index

Part Code	Product Description	Cap	Page
FTT549SPCW	49W Fluorescent T5 (HO) 4000K	G5	103
FTT549SPDYL	49W Fluorescent T5 (HO) 6500K	G5	103
FTT54SPCW	54W Fluorescent T5 (HO) 4000K	G5	103
FTT580PCW	80W Fluorescent T5 (HO) 4000K	G5	103
IR250HGBC	250W IR Reflector Clear Hard Glass	BC-B22d	117
IR250HGDES	250W IR Reflector Diffused Hard Glass	ES-E27	117
IR250HGRES	250W IR Reflector Ruby Hard Glass	ES-E27	117
LFT29CW	9W 2ft LED T8 Tube 4000K	G13	86
LFT29CW-SF	9W 2ft LED Foodsafe T8 Tube 4000K	G13	87
LFT29DL	9W 2ft LED T8 Tube 6500K	G13	86
LFT29DL-SF	9W 2ft LED Foodsafe T8 Tube 6500K	G13	87
LFT29WW	9W 2ft LED T8 Tube 3000K	G13	86
LFT29WW-SF	9W 2ft LED Foodsafe T8 Tube 3000K	G13	87
LFT314CW	14W 3ft LED T8 Tube 4000K	G13	86
LFT314CW-SF	14W 3ft LED Foodsafe T8 Tube 4000K	G13	87
LFT314DL	14W 3ft LED T8 Tube 6500K	G13	86
LFT314DL-SF	14W 3ft LED Foodsafe T8 Tube 6500K	G13	87
LFT314WW	14W 3ft LED T8 Tube 3000K	G13	86
LFT314WW-SF	14W 3ft LED Foodsafe T8 Tube 3000K	G13	87
LFT422CW	22W 4ft LED T8 Tube 4000K	G13	86
LFT422CW-SF	22W 4ft LED Foodsafe T8 Tube 4000K	G13	87
LFT422DL	22W 4ft LED T8 Tube 6500K	G13	86
LFT422DL-SF	22W 4ft LED Foodsafe T8 Tube 6500K	G13	87
LFT422WW	22W 4ft LED T8 Tube 3000K	G13	86
LFT422WW-SF	22W 4ft LED Foodsafe T8 Tube 3000K	G13	87
LFT524CW	24W 5ft LED T8 Tube 4000K	G13	86
LFT524CW-SF	24W 5ft LED Foodsafe T8 Tube 4000K	G13	87
LFT524DL	24W 5ft LED T8 Tube 6500K	G13	86
LFT524DL-SF	24W 5ft LED Foodsafe T8 Tube 6500K	G13	87
LFT524WW	24W 5ft LED T8 Tube 3000K	G13	86
LFT524WW-SF	24W 5ft LED Foodsafe T8 Tube 3000K	G13	87
LFT628CW	28W 6ft LED T8 Tube 4000K	G13	86
LFT628CW-SF	28W 6ft LED Foodsafe T8 Tube 4000K	G13	87
LFT628DL	28W 6ft LED T8 Tube 6500K	G13	86
LFT628DL-SF	28W 6ft LED Foodsafe T8 Tube 6500K	G13	87
LGU105CWO	5W LED GU10 COB 4000K	GU10	72
LGU105CWO-DIM	5W LED GU10 COB Dim 4000K	GU10	72
LGU105DLCO	5W LED GU10 COB 6000K	GU10	72
LGU105DLCO-DIM	5W LED GU10 COB Dim 6000K	GU10	72
LGU105WCO	5W LED GU10 COB 3000K	GU10	72
LGU105WCO-DIM	5W LED GU10 COB Dim 3000K	GU10	72
MHE250WGESDU4K	250W Elliptical Dual MH Enclosed 4100K	GES-E40	111
MHE400WGESDU4K	400W Elliptical Dual MH Enclosed 4100K	GES-E40	111
MHE400WGESHP4K	400W Elliptical MH Open 4100K	GES-E40	109
MHE70WGESHP4K	70W Elliptical MH Open 4100K	ES-E27	109
MHOTS150N	150W Double Ended MH 4200K	RX7s	108
MHOTS150W	150W Double Ended MH 3000K	RX7s	108
MHOTS70N	70W Double Ended MH 4200K	RX7s	108

Part Code	Product Description	Cap	Page
MHOTS70W	70W Double Ended MH 3000K	RX7s	108
MHT150WESHSPEN4K	150W Tubular Clear MH Enclosed SON	ES-E27	110
MHT250WGESDU4K	250W Tubular Dual MH Enclosed	GES-E40	111
MHT250WESHSPEN4K	250W Tubular Clear MH Enclosed SON	GES-E40	110
MHT250WGESMER4K	250W Tubular Clear MH Enclosed MER	GES-E40	110
MHT250XPS4K	250W Tubular Single Ended Pulse Start MH	GES-E40	114
MHT400WGESDU4K	400W Tubular Dual MH Enclosed	GES-E40	111
MHT400WGESMER4K	400W Tubular Clear MH Enclosed MER	GES-E40	110
MHT400XPS4K	400W Tubular Single Ended Pulse Start MH	GES-E40	114
MHT70WESHSPEN4K	70W Tubular Clear MH Enclosed SON	ES-E27	110
MHTCER150WG124K	150W Ceramic MH 4100K	G12	107
MHTCER70WG8.53K	70W Ceramic MH 3000K	G8.5	107
ROU15ABC-GLZ	15W Colouglazed Round Amber	BC-B22d	121
ROU15BBC-GLZ	15W Colouglazed Round Blue	BC-B22d	121
ROU15CBC-GLZ	15W Colouglazed Round Clear	BC-B22d	121
ROU15GBC-GLZ	15W Colouglazed Round Green	BC-B22d	121
ROU15RBC-GLZ	15W Colouglazed Round Red	BC-B22d	121
ROU15WBC-GLZ	15W Colouglazed Round White	BC-B22d	121
ROU15YBC-GLZ	15W Colouglazed Round Yellow	BC-B22d	121
SIG15ABC	15W Colouglazed Sign Amber	BC-B22d	120
SIG15ASES	15W Colouglazed Sign Amber	SES-E14	120
SIG15BBC	15W Colouglazed Sign Blue	BC-B22d	120
SIG15BSES	15W Colouglazed Sign Blue	SES-E14	120
SIG15CBC	15W Clear Sign	BC-B22d	119
SIG15CSBC	15W Clear Sign	SBC-B15d	119
SIG15CSES	15W Clear Sign	SES-E14	119
SIG15GBC	15W Colouglazed Sign Green	BC-B22d	120
SIG15GSES	15W Colouglazed Sign Green	SES-E14	120
SIG15PBC	15W Colouglazed Sign Pink	BC-B22d	120
SIG15PSES	15W Colouglazed Sign Pink	SES-E14	120
SIG15RBC	15W Colouglazed Sign Red	BC-B22d	120
SIG15RSBC	15W Colouglazed Sign Red	SBC-B15d	120
SIG15RSES	15W Colouglazed Sign Red	SES-E14	120
SIG15WBC	15W Colouglazed Sign White	BC-B22d	120
SIG15WSES	15W Colouglazed Sign White	SES-E14	120
SIG15YBC	15W Colouglazed Sign Yellow	BC-B22d	120
SIG15YSES	15W Colouglazed Sign Yellow	SES-E14	120
SIG25CBC	25W Clear Sign	BC-B22d	119
SIG25CSBC	25W Clear Sign	SBC-B15d	119
SIG25CSES	25W Clear Sign	SES-E14	119
SONH0150	150W Elliptical HPS (SON HO) 2000K	GES-E40	112
SONH070	70W Elliptical HPS (SON HO) 2000K	ES-E27	112
SONH070I	70W Elliptical HPS Internal (SON HO) 2000K	ES-E27	112
SONTH0150	150W Tubular HPS (SON HO) 2000K	GES-E40	113
SONTH0250	250W Tubular HPS (SON HO) 2000K	GES-E40	113
SONTH0400	400W Tubular HPS (SON HO) 2000K	GES-E40	113
SONTH070	70W Tubular HPS (SON HO) 2000K	ES-E27	113

**PHOEBE
LED**

10W Spectrum LED Downlight

With Bluetooth App and
Smart Switch Control



RGB Colour Changing Rim



Spectrum Smart Switch

- Mains operated 40° downlight available with ambient RGB halolight rim
- Fully dimmable single/twin light outputs controllable from smartphone app or smart switch
- Tuneable white spotlight from 2200K extra warm white to 6500K daylight
- Complete with 3x magnetic quick-change front bezels
- Bluetooth app/smart switch controlled
- IP65 rated with 30, 60, 90 minuted fire rating*



Supplied with 3x Bezels, white, chrome and brushed steel
Optional Gloss Black and Antique Bronze Bezels available separately

For demonstration videos visit www.cromptonlamps.com

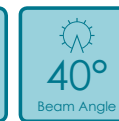
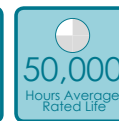
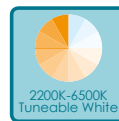
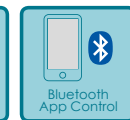
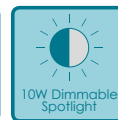

* Part L Compliant of UK Building Regulations, Part B Compliant BS476 Parts 21 and 22. Suitable for 30 minute 600mm/15mm single layer standard wallboard, 60 minute 600mm/12.5mm twin layer fireboard and 90 minute 450mm/15mm twin layer fireboard ceilings.



Contact Us

Crompton Lamps Limited
Unit 2
Marrtree Business Park
Bowling Back Lane
Bradford
BD4 8QE

Using Sat Nav?
BD4 8TP

Tel: 01274 657 088

Fax: 01274 657 087

Email: lamps@cromptonlamps.com

Web: www.cromptonlamps.com

UK Sales

Tel: 01274 657 088

Fax: 01274 657 087

Email: sales@cromptonlamps.com

Customer Services

Email: sales@cromptonlamps.com

Conditions of Sale

All goods supplied are subject to the company's general conditions of sale which are available on request.

Trade Descriptions

All descriptions represent only particulars of the goods to which they apply and do not form part of any contract. Due to a policy of continuous development and improvement, Crompton Lamps Limited reserves the right to change the specification and performance data of the products listed without prior notice or public announcement.

Design and Production by

Marketing, Crompton Lamps Limited

E. & O. E. © Crompton Lamps Limited 2020.

All rights reserved

Publication Ref: CL14 24 November 2020

Printed in the UK

Crompton Lamps Limited registered in England and Wales No. 05590551



Compliant

Listed in  Trimble
LUCKINSTM



Lighting brilliance since 1878



Your Local Stockist



Lighting brilliance since 1878